

High-Temp Industries

Superior Quality
Comprehensive Services
Unequaled Value

Cartridge Heaters 2012

Phone 215-794-0864

Fax 215-794-7583

www.high-temp.com

Table of Contents

High-Watt Density Cartridge Heaters	3
Medium Watt Density Cartridge Heaters	4
Cartridge Heater Technical Specifications	5
Available Heater Sizes	5
Stock .125" Diameter Heaters	6
Stock .25" Diameter Heaters	7
.25" Diameter Options Selection	9
Stock .375" Diameter Heaters	14
.375" Diameter Options Selection	19
Stock .5" Diameter Heaters	23
.5" Diameter Options Selection	28
Stock .625" Diameter Heaters	32
.625" Diameter Options Selection	36
Stock .75" Diameter Heaters	39
.75" Diameter Options Selection	42
Stock 1" Diameter Heaters	46
1" Diameter Options Selection	49
DME Equivalent Low Watt Density Heaters	53
Hot Runner Heaters with Internal Thermocouples	56
.25" Probe Heaters without Thermocouple	57
.375" Probe Heaters with Thermocouple	58
.5" Hot Runner Heaters with Thermocouple	59
.5" Diameter Tube Heaters with Thermocouple	60
.625" Diameter Tube Heaters with Thermocouple	61
OEM Incoe Probe Heaters with Thermocouple	62

High-Watt Density Cartridge Heaters

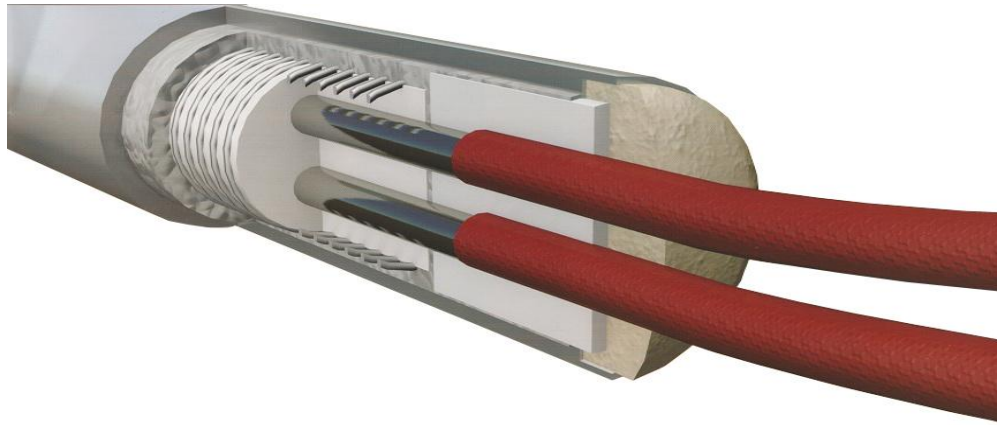

High-Temp Industries high watt density cartridge heaters are manufactured to the highest standards using only premium materials. Our tight manufacturing controls result in uniform surface temperatures and resistance to oxidation and corrosion, even at elevated temperatures. Our high watt density cartridge heaters are designed for extreme temperatures and longer life, even in the most severe, rugged and demanding applications. Their heavy duty construction provides high dielectric strength as well as shock and vibration resistance. Our heaters are available in diameters from .125" to 1" and voltages from 12v to 480v with watt density up to 165wsq². Warranties are up to 2 years against manufacture defects.

Features:

- Incoloy or Stainless Steel Sheath: Selected heavy wall tubing gives maximum heat transfer, high compaction and is corrosion resistant.
- Ceramic Potting: High density material locks the magnesium oxide in place, acting like an insulator between pin and sheath and also resists contamination.
- Leads: Flexible, non-asbestos fiberglass leads, swaged internally connected.
- Swaging: Compression of the magnesium oxide ensuring longer life.
- Centering: MGO spacer precisely centers the wire wound core, eliminating hot spots.

Medium Watt Density Cartridge Heaters



High-Temp Industries medium watt density cartridge heaters are recommended whenever the performance of a high watt density heater is not fully needed. The construction of our medium watt density cartridge heaters utilize the same high quality material as in our high watt density heaters, except instead of a ceramic core with 80/20 nichrome wire wound on the exterior, we use the same 80/20 nichrome wire in a spiral wound design threaded thru a ceramic core with multiple channels internally. Our medium watt density cartridge heaters are an excellent choice when utilized in a low vibration environment where an internal thermocouple is not required. These heaters are able to achieve temperatures up to 900°F and are an excellent choice for cartridge heaters greater than 8" in length where watt per square inch is less than 60wsq². Our heaters are available in voltages from 12v to 480v and diameters from .25" to 1" and metric sizes from 6mm to 25.4mm. Applications include:

- Injection molding manifolds
- Packaging machinery
- Bolt heaters
- Heated platens
- Extruder heads
- Food processing machinery

Cartridge Heater Technical Specifications

Watt Density	Warranty up to 150W²
Voltage	Dependent Upon Diameter
Hipot	<=0.1mA a 240 v.
M Ohms	>5 mOhms @ 500 Watts minimum
Dielectric Strength	1500v. 1/seg
Working Temperature	1500°F
Tolerance of Length	+/-1.5%
Tolerance of Diameter	.002"-.004"
Lead Wire Tolerance	+/-1/2"
Power Tolerance (w)	+ 5 % - 10 %
Cold Areas	Dependent Upon Diameter

Available Heater Sizes

Imperial	1/8"	1/4"	5/16"	3/8"	1/2"	5/8"	3/4"	1.00"
Metric	3.1mm	4mm	5mm	6mm	6.5mm	7mm	8mm	10mm
	11mm	12mm	14mm	16mm	18mm	20mm	22mm	25mm

Stock .125" Diameter Heaters



High-Temp Industries 1/8-inch (.125") cartridge heater features a helically wound resistance wire that produces higher watt densities and contributes to longer service life in space-restricted applications. Industry trends show a reduction in medical equipment size and movement toward manufacturing more ambulatory equipment. Our heaters are compatible with the reduced equipment size and have the ability to work at a high watt density without compromising service life. This makes the heater ideal for space-restricted applications within the aviation, packaging, freeze protection, ink jet printer and gas chromatography industries. Similar to other cartridge heaters, High-Temp Industries 1/8-inch (.125") stainless steel sheath is resistant to oxidation and corrosion, even at high temperatures. It also undergoes a swaging procedure that is designed to improve dielectric strength, heat transfer and tolerance to shock and vibration. Swaging is a procedure that involves reducing a cartridge heater's diameter by compressing the cartridge heater body filled with magnesium oxide powder to a specific diameter around the resistance and lead wires. This reduces the spacing between the resistance wires and metal sheath, and compacts the magnesium oxide insulation, which minimizes insulation space and maximizes heat transfer. Users can achieve desired process temperatures more quickly, and the resistance wires operate at lower temperatures, which is ideal for reducing energy costs and an important factor increasing the heater life. High-Temp Industries 1/8-inch (.125") cartridge heaters are available with crimped-on or swaged-in leads with optional Teflon[®] moisture resistant seals and leads. Mounting options include a one-inch diameter mounting flange (FS flange), and a 90° angle-bend version.

Stock .25" Diameter Heaters

LENGTH	VOLTS	WATTS	14" LEADS	PRICE	26" LEADS	PRICE	38" LEADS	PRICE
1	120	55	HT25010A-14S	\$20.66	HT25010A-26S	\$24.74	HT25010A-38S	\$28.82
1	120	100	HT25010B-14S	\$20.66	HT25010B-26S	\$24.74	HT25010B-38S	\$28.82
1	240	100	HT25010C-14S	\$20.66	HT25010C-26S	\$24.74	HT25010C-38S	\$28.82
1.25	120	75	HT25012A-14S	\$20.66	HT25012A-26S	\$24.74	HT25012A-38S	\$28.82
1.5	120	50	HT25015B-14S	\$22.46	HT25015B-26S	\$26.54	HT25015B-38S	\$30.62
1.5	120	100	HT25015C-14S	\$22.46	HT25015C-26S	\$26.54	HT25015C-38S	\$30.62
1.5	120	150	HT25015D-14S	\$22.46	HT25015D-26S	\$26.54	HT25015D-38S	\$30.62
1.5	240	150	HT25015E-14S	\$22.46	HT25015E-26S	\$26.54	HT25015E-38S	\$30.62
1.5	120	200	HT25015F-14S	\$22.46	HT25015F-26S	\$26.54	HT25015F-38S	\$30.62
1.5	240	200	HT25015B-14S	\$22.46	HT25015B-26S	\$26.54	HT25015B-38S	\$30.62
2	120	50	HT25020A-14S	\$25.61	HT25020A-26S	\$29.69	HT25020A-38S	\$33.77
2	120	100	HT25020B-14S	\$25.61	HT25020B-26S	\$29.69	HT25020B-38S	\$33.77
2	120	150	HT25020C-14S	\$25.61	HT25020C-26S	\$29.69	HT25020C-38S	\$33.77
2	240	150	HT25020D-14S	\$25.61	HT25020D-26S	\$29.69	HT25020D-38S	\$33.77
2	120	200	HT25020E-14S	\$25.61	HT25020E-26S	\$29.69	HT25020E-38S	\$33.77
2	240	200	HT25020A-14S	\$25.61	HT25020A-26S	\$29.69	HT25020A-38S	\$33.77
2	120	250	HT25020G-14S	\$25.61	HT25020G-26S	\$29.69	HT25020G-38S	\$33.77
2	240	250	HT25020H-14S	\$25.61	HT25020H-26S	\$29.69	HT25020H-38S	\$33.77
2.5	120	200	HT25025A-14S	\$25.61	HT25025A-26S	\$29.69	HT25025A-38S	\$33.77
2.5	240	200	HT25025B-14S	\$25.61	HT25025B-26S	\$29.69	HT25025B-38S	\$33.77
3	120	75	HT25030A-14S	\$28.76	HT25030A-26S	\$32.84	HT25030A-38S	\$36.92
3	120	150	HT25030B-14S	\$28.76	HT25030B-26S	\$32.84	HT25030B-38S	\$36.92
3	120	200	HT25030C-14S	\$28.76	HT25030C-26S	\$32.84	HT25030C-38S	\$36.92
3	240	200	HT25030D-14S	\$28.76	HT25030D-26S	\$32.84	HT25030D-38S	\$36.92
3	120	300	HT25030E-14S	\$28.76	HT25030E-26S	\$32.84	HT25030E-38S	\$36.92
3	240	300	HT25030A-14S	\$28.76	HT25030A-26S	\$32.84	HT25030A-38S	\$36.92
4	120	100	HT25040A-14S	\$31.91	HT25040A-26S	\$35.99	HT25040A-38S	\$40.07
4	120	200	HT25040B-14S	\$31.91	HT25040B-26S	\$35.99	HT25040B-38S	\$40.07
4	240	200	HT25040C-14S	\$31.91	HT25040C-26S	\$35.99	HT25040C-38S	\$40.07
4	120	300	HT25040D-14S	\$31.91	HT25040D-26S	\$35.99	HT25040D-38S	\$40.07
4	240	300	HT25040E-14S	\$31.91	HT25040E-26S	\$35.99	HT25040E-38S	\$40.07

Stock .25" Diameter Heaters (Continued)

LENGTH	VOLTS	WATTS	14" LEADS	PRICE	26" LEADS	PRICE	38" LEADS	PRICE
4	120	400	HT25040F-14S	\$31.91	HT25040F-26S	\$35.99	HT25040F-38S	\$40.07
4	240	400	HT25040A-14S	\$31.91	HT25040A-26S	\$35.99	HT25040A-38S	\$40.07
4.5	120	200	HT25045A-14S	\$31.91	HT25045A-26S	\$35.99	HT25045A-38S	\$40.07
5	120	125	HT25050A-14S	\$35.06	HT25050A-26S	\$39.14	HT25050A-38S	\$43.22
5	120	300	HT25050B-14S	\$35.06	HT25050B-26S	\$39.14	HT25050B-38S	\$43.22
5	120	500	HT25050C-14S	\$35.06	HT25050C-26S	\$39.14	HT25050C-38S	\$43.22
5	240	500	HT25050A-14S	\$35.06	HT25050A-26S	\$39.14	HT25050A-38S	\$43.22
6	120	150	HT25060A-14S	\$38.16	HT25060A-26S	\$42.24	HT25060A-38S	\$46.32
6	240	150	HT25060B-14S	\$38.16	HT25060B-26S	\$42.24	HT25060B-38S	\$46.32
6	120	600	HT25060C-14S	\$38.16	HT25060C-26S	\$42.24	HT25060C-38S	\$46.32
6	240	600	HT25060A-14S	\$38.16	HT25060A-26S	\$42.24	HT25060A-38S	\$46.32
7	120	300	HT25070A-14S	\$41.31	HT25070A-26S	\$45.39	HT25070A-38S	\$49.47
7	240	300	HT25070B-14S	\$41.31	HT25070B-26S	\$45.39	HT25070B-38S	\$49.47
8	120	400	HT25080A-14S	\$44.46	HT25080A-26S	\$48.54	HT25080A-38S	\$52.62
8	240	400	HT25080B-14S	\$44.46	HT25080B-26S	\$48.54	HT25080B-38S	\$52.62
10	240	500	HT25100A-14S	\$48.76	HT25100A-26S	\$52.67	HT25080A-38S	\$56.89
12	240	500	HT25120A-14S	\$52.86	HT25120A-26S	\$56.00	HT25120A-38S	\$60.56

Do not see what you need?

We can build to your specifications!

.25" Diameter Options Selection

Lead Options



Price	No Additional Charge
-------	----------------------

Solid Nickel Pins

Utilized in high heat applications and where there is no movement or vibration. Lead wires can be added via exterior crimps. Damaged wires can be replaced quickly.



Price	First 14"	Per Additional 12"
	No Charge	\$2.79

Fiberglass Leads (Standard)

Pure nickel conductors insulated with 950°F fiberglass insulation.



Price	First 14"	Per Additional 12"
	\$3.73	\$1.89

Silicon Leads

Ideal for high-movement, limited heat applications. Can withstand temperatures up to 450°F. Provides limited protection to moisture. Requires silicon potting to be utilized.



Price	First 14"	Per Additional 12"
	\$3.73	\$1.89

Teflon Leads

Ideal for excessive movement and high vibration applications. Can withstand temperatures up to 450°F. Provides limited protection from moisture. Requires either silicon potting or a Teflon seal.

.25" Diameter Options Selection

Lead Protection Options



Price	First 12"	Per Additional 12"
	\$3.99	\$1.78

Fiberglass Sleeving

Protection against temperatures up to 950°F while providing moderate protection against friction.



Price	First 12"	Per additional 12"
	\$9.89	\$4.15

Braided Metal Sleeving (BMS)

Ideal for high friction and constant bending. Stainless steel construction with high flexibility.



Price	First 12"	Per additional 12"
	\$13.25	\$5.55

Armor Conduit

Water resistant interlocking design allows for limited exposure to moisture. Flexibility allows an added level of protection against physical damage to the lead wires.

All options can be added to stock items and shipped within 24 hours of ordering!

.25" Diameter Options Selections

NPT Fittings

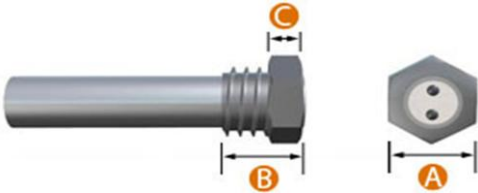

	Stainless Steel	Brass
Price	\$15.89	\$13.97

Specifications	1/4" Diameter
A	.433"
B	.625"
C	.157"
NPT Fitting	1/8

Right Angle Block Exit with Knockout Tab

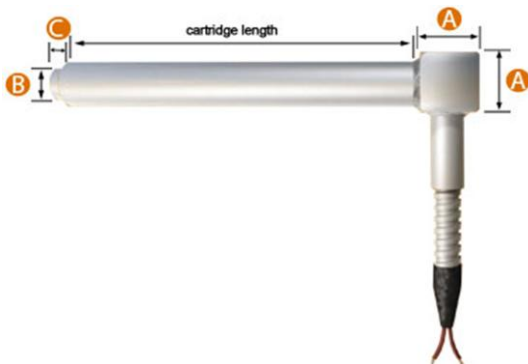

	Right Angle Block	Knockout Tab
Price	\$16.20	\$6.73

Specifications	1/4" Diameter
A (Right Angle Block)	.315"
B (Knockout Tab)	.157"
C (Knockout Tab)	.118"

All options can be added to stock items and shipped within 24 hours of ordering!

.25" Diameter Options Selections

Flange



Specifications		
A	1.00"	1.50"
B	0.75"	1.10"
C	.177"	.177"

Specifications	1" Flange	1.5" Flange
Price	\$10.20	\$10.73

Mounting Tab



Specifications	
A	.240"
B	.315"
C	.393"

Price	\$10.20
-------	---------

All options can be added to stock items and shipped within 24 hours of ordering!

.25" Diameter Options Selections

Optional Exit Styles

Right Angle Exit

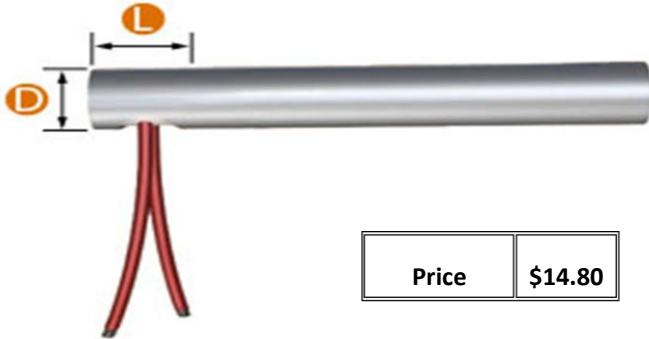

Price	\$14.80
-------	---------

Specifications	
D	.240"
L	.500"

Right Angle Exit with Stress Relief Tube

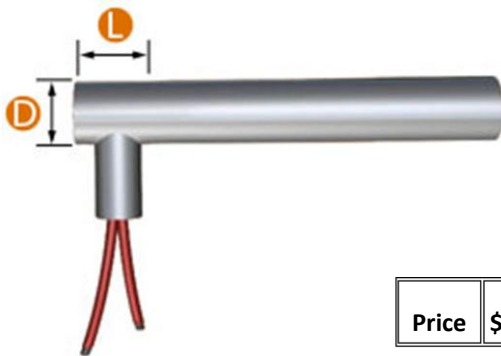

Price	\$17.80
-------	---------

Specifications	
D	.240"
L	.500"

Right Angle Elbow

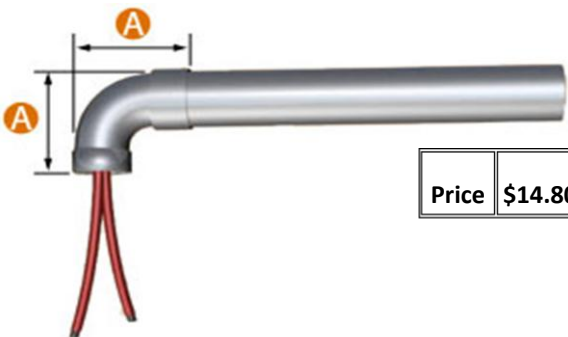

Price	\$14.80
-------	---------

Specifications	
A	.625"

All options can be added to stock items and shipped within 24 hours of ordering!

Stock .375" Diameter Heaters

LENGTH	VOLTS	WATTS	14" LEADS	PRICE	26" LEADS	PRICE	38" LEADS	PRICE
1	240	100	HT37010A-14S	\$21.08	HT37010A-26S	\$25.52	HT37010A-38S	\$29.96
1.25	240	100	HT37012A-14S	\$23.08	HT37012A-26S	\$27.52	HT37012A-38S	\$31.96
1.25	240	150	HT37012B-14S	\$23.08	HT37012B-26S	\$27.52	HT37012B-38S	\$31.96
1.5	120	50	HT37015A-14S	\$23.08	HT37015A-26S	\$27.52	HT37015A-38S	\$31.96
1.5	120	100	HT37015B-14S	\$23.08	HT37015B-26S	\$27.52	HT37015B-38S	\$31.96
1.5	240	100	HT37015C-14S	\$23.08	HT37015C-26S	\$27.52	HT37015C-38S	\$31.96
1.5	120	150	HT37015D-14S	\$23.08	HT37015D-26S	\$27.52	HT37015D-38S	\$31.96
1.5	240	150	HT37015E-14S	\$23.08	HT37015E-26S	\$27.52	HT37015E-38S	\$31.96
1.5	120	200	HT37015F-14S	\$23.08	HT37015F-26S	\$27.52	HT37015F-38S	\$31.96
1.5	240	200	HT37015A-14S	\$23.08	HT37015A-26S	\$27.52	HT37015A-38S	\$31.96
1.5	120	250	HT37015H-14S	\$23.08	HT37015H-26S	\$27.52	HT37015H-38S	\$31.96
1.5	240	250	HT37015J-14S	\$23.08	HT37015J-26S	\$27.52	HT37015J-38S	\$31.96
1.75	120	50	HT37017A-14S	\$26.63	HT37017A-26S	\$31.07	HT37017A-38S	\$35.51
1.75	240	200	HT37017A-14S	\$26.63	HT37017A-26S	\$31.07	HT37017A-38S	\$35.51
2	120	50	HT37020A-14S	\$26.63	HT37020A-26S	\$31.07	HT37020A-38S	\$35.51
2	120	75	HT37020B-14S	\$26.63	HT37020B-26S	\$31.07	HT37020B-38S	\$35.51
2	120	100	HT37020C-14S	\$26.63	HT37020C-26S	\$31.07	HT37020C-38S	\$35.51
2	240	100	HT37020D-14S	\$26.63	HT37020D-26S	\$31.07	HT37020D-38S	\$35.51
2	120	150	HT37020E-14S	\$26.63	HT37020E-26S	\$31.07	HT37020E-38S	\$35.51
2	240	150	HT37020F-14S	\$26.63	HT37020F-26S	\$31.07	HT37020F-38S	\$35.51
2	120	200	HT37020G-14S	\$26.63	HT37020G-26S	\$31.07	HT37020G-38S	\$35.51
2	240	200	HT37020A-14S	\$26.63	HT37020A-26S	\$31.07	HT37020A-38S	\$35.51
2	120	250	HT37020M-14S	\$26.63	HT37020M-26S	\$31.07	HT37020M-38S	\$35.51
2	240	250	HT37020J-14S	\$26.63	HT37020J-26S	\$31.07	HT37020J-38S	\$35.51
2	120	300	HT37020K-14S	\$26.63	HT37020K-26S	\$31.07	HT37020K-38S	\$35.51
2	240	300	HT37020B-14S	\$26.63	HT37020B-26S	\$31.07	HT37020B-38S	\$35.51
2.5	120	250	HT37025A-14S	\$26.63	HT37025A-26S	\$31.07	HT37025A-38S	\$35.51
2.5	240	250	HT37025B-14S	\$26.63	HT37025B-26S	\$31.07	HT37025B-38S	\$35.51
3	120	100	HT37030A-14S	\$30.18	HT37030A-26S	\$34.62	HT37030A-38S	\$39.06
3	120	125	HT37030B-14S	\$30.18	HT37030B-26S	\$34.62	HT37030B-38S	\$39.06
3	120	150	HT37030K-14S	\$30.18	HT37030K-26S	\$34.62	HT37030K-38S	\$39.06

Stock .375" Diameter Heaters (Continued)

LENGTH	VOLTS	WATTS	14" LEADS	PRICE	26" LEADS	PRICE	38" LEADS	PRICE
3	240	150	HT37030L-14S	\$30.18	HT37030L-26S	\$34.62	HT37030L-38S	\$39.06
3	120	200	HT37030C-14S	\$30.18	HT37030C-26S	\$34.62	HT37030C-38S	\$39.06
3	240	200	HT37030D-14S	\$30.18	HT37030D-26S	\$34.62	HT37030D-38S	\$39.06
3	120	250	HT37030E-14S	\$30.18	HT37030E-26S	\$34.62	HT37030E-38S	\$39.06
3	240	250	HT37030F-14S	\$30.18	HT37030F-26S	\$34.62	HT37030F-38S	\$39.06
3	120	300	HT37030G-14S	\$30.18	HT37030G-26S	\$34.62	HT37030G-38S	\$39.06
3	240	300	HT37030H-14S	\$30.18	HT37030H-26S	\$34.62	HT37030H-38S	\$39.06
3	120	400	HT37030J-14S	\$30.18	HT37030J-26S	\$34.62	HT37030J-38S	\$39.06
3	240	400	HT37030A-14S	\$30.18	HT37030A-26S	\$34.62	HT37030A-38S	\$39.06
3	120	500	HT37030L-14S	\$30.18	HT37030L-26S	\$34.62	HT37030L-38S	\$39.06
3	240	500	HT37030B-14S	\$30.18	HT37030B-26S	\$34.62	HT37030B-38S	\$39.06
3.5	120	75	HT37035A-14S	\$30.18	HT37035A-26S	\$34.62	HT37035A-38S	\$39.06
3.5	120	125	HT37035D-14S	\$30.18	HT37035D-26S	\$34.62	HT37035D-38S	\$39.06
3.5	120	300	HT37035B-14S	\$30.18	HT37035B-26S	\$34.62	HT37035B-38S	\$39.06
3.5	240	300	HT37035A-14S	\$30.18	HT37035A-26S	\$34.62	HT37035A-38S	\$39.06
3.5	120	500	HT37035C-14S	\$30.18	HT37035C-26S	\$34.62	HT37035C-38S	\$39.06
3.5	240	500	HT37035D-14S	\$30.18	HT37035D-26S	\$34.62	HT37035D-38S	\$39.06
4	120	125	HT37040A-14S	\$33.73	HT37040A-26S	\$38.17	HT37040A-38S	\$42.61
4	120	150	HT37040B-14S	\$33.73	HT37040B-26S	\$38.17	HT37040B-38S	\$42.61
4	240	150	HT37040H-14S	\$33.73	HT37040H-26S	\$38.17	HT37040H-38S	\$42.61
4	120	250	HT37040C-14S	\$33.73	HT37040C-26S	\$38.17	HT37040C-38S	\$42.61
4	240	250	HT37040D-14S	\$33.73	HT37040D-26S	\$38.17	HT37040D-38S	\$42.61
4	120	400	HT37040E-14S	\$33.73	HT37040E-26S	\$38.17	HT37040E-38S	\$42.61
4	240	400	HT37040F-14S	\$33.73	HT37040F-26S	\$38.17	HT37040F-38S	\$42.61
4	120	500	HT37040G-14S	\$33.73	HT37040G-26S	\$38.17	HT37040G-38S	\$42.61
4	240	500	HT37040A-14S	\$33.73	HT37040A-26S	\$38.17	HT37040A-38S	\$42.61
4	240	600	HT37040B-14S	\$33.73	HT37040B-26S	\$38.17	HT37040B-38S	\$42.61
4.5	120	125	HT37045A-14S	\$33.73	HT37045A-26S	\$38.17	HT37045A-38S	\$42.61
4.5	120	300	HT37045B-14S	\$33.73	HT37045B-26S	\$38.17	HT37045B-38S	\$42.61
4.5	120	500	HT37045C-14S	\$33.73	HT37045C-26S	\$38.17	HT37045C-38S	\$42.61
4.5	240	500	HT37045A-14S	\$33.73	HT37045A-26S	\$38.17	HT37045A-38S	\$42.61
5	120	100	HT37050E-14S	\$37.28	HT37050E-26S	\$41.72	HT37050E-38S	\$46.16

Stock .375" Diameter Heaters (Continued)

LENGTH	VOLTS	WATTS	14" LEADS	PRICE	26" LEADS	PRICE	38" LEADS	PRICE
5	120	125	HT37050N-14S	\$37.28	HT37050N-26S	\$41.72	HT37050N-38S	\$46.16
5	120	150	HT37050B-14S	\$37.28	HT37050B-26S	\$41.72	HT37050B-38S	\$46.16
5	240	150	HT37050J-14S	\$37.28	HT37050J-26S	\$41.72	HT37050J-38S	\$46.16
5	120	200	HT37050H-14S	\$37.28	HT37050H-26S	\$41.72	HT37050H-38S	\$46.16
5	120	250	HT37050C-14S	\$37.28	HT37050C-26S	\$41.72	HT37050C-38S	\$46.16
5	120	300	HT37050K-14S	\$37.28	HT37050K-26S	\$41.72	HT37050K-38S	\$46.16
5	240	300	HT37050L-14S	\$37.28	HT37050L-26S	\$41.72	HT37050L-38S	\$46.16
5	120	400	HT37050D-14S	\$37.28	HT37050D-26S	\$41.72	HT37050D-38S	\$46.16
5	240	400	HT37050E-14S	\$37.28	HT37050E-26S	\$41.72	HT37050E-38S	\$46.16
5	120	500	HT37050M-14S	\$37.28	HT37050M-26S	\$41.72	HT37050M-38S	\$46.16
5	240	500	HT37050N-14S	\$37.28	HT37050N-26S	\$41.72	HT37050N-38S	\$46.16
5	120	600	HT37050F-14S	\$37.28	HT37050F-26S	\$41.72	HT37050F-38S	\$46.16
5	240	600	HT37050B-14S	\$37.28	HT37050B-26S	\$41.72	HT37050B-38S	\$46.16
5	240	800	HT37050H-14S	\$37.28	HT37050H-26S	\$41.72	HT37050H-38S	\$46.16
5	240	1000	HT37050C-14S	\$37.28	HT37050C-26S	\$41.72	HT37050C-38S	\$46.16
6	120	100	HT37060E-14S	\$40.83	HT37060E-26S	\$45.27	HT37060E-38S	\$49.71
6	120	125	HT37060K-14S	\$40.83	HT37060K-26S	\$45.27	HT37060K-38S	\$49.71
6	120	150	HT37060A-14S	\$40.83	HT37060A-26S	\$45.27	HT37060A-38S	\$49.71
6	120	200	HT37060B-14S	\$40.83	HT37060B-26S	\$45.27	HT37060B-38S	\$49.71
6	120	250	HT37060C-14S	\$40.83	HT37060C-26S	\$45.27	HT37060C-38S	\$49.71
6	240	250	HT37060F-14S	\$40.83	HT37060F-26S	\$45.27	HT37060F-38S	\$49.71
6	120	300	HT37060G-14S	\$40.83	HT37060G-26S	\$45.27	HT37060G-38S	\$49.71
6	240	300	HT37060H-14S	\$40.83	HT37060H-26S	\$45.27	HT37060H-38S	\$49.71
6	120	400	HT37060D-14S	\$40.83	HT37060D-26S	\$45.27	HT37060D-38S	\$49.71
6	240	400	HT37060E-14S	\$40.83	HT37060E-26S	\$45.27	HT37060E-38S	\$49.71
6	120	500	HT37060J-14S	\$40.83	HT37060J-26S	\$45.27	HT37060J-38S	\$49.71
6	240	500	HT37060K-14S	\$40.83	HT37060K-26S	\$45.27	HT37060K-38S	\$49.71
6	240	600	HT37060A-14S	\$40.83	HT37060A-26S	\$45.27	HT37060A-38S	\$49.71
6	240	800	HT37060B-14S	\$40.83	HT37060B-26S	\$45.27	HT37060B-38S	\$49.71
6	240	1000	HT37060C-14S	\$40.83	HT37060C-26S	\$45.27	HT37060C-38S	\$49.71
6.5	120	500	HT37065A-14S	\$40.83	HT37065A-26S	\$45.27	HT37065A-38S	\$49.71
6.5	240	500	HT37065B-14S	\$40.83	HT37065B-26S	\$45.27	HT37065B-38S	\$49.71
7	120	250	HT37070A-14S	\$44.38	HT37070A-26S	\$48.82	HT37070A-38S	\$53.26
7	120	400	HT37070B-14S	\$44.38	HT37070B-26S	\$48.82	HT37070B-38S	\$53.26

Stock .375" Diameter Heaters (Continued)

LENGTH	VOLTS	WATTS	14" LEADS	PRICE	26" LEADS	PRICE	38" LEADS	PRICE
7	240	400	HT37070C-14S	\$44.38	HT37070C-26S	\$48.82	HT37070C-38S	\$53.26
7	120	500	HT37070D-14S	\$44.38	HT37070D-26S	\$48.82	HT37070D-38S	\$53.26
7	240	500	HT37070E-14S	\$44.38	HT37070E-26S	\$48.82	HT37070E-38S	\$53.26
7	120	600	HT37070F-14S	\$44.38	HT37070F-26S	\$48.82	HT37070F-38S	\$53.26
7	240	600	HT37070G-14S	\$44.38	HT37070G-26S	\$48.82	HT37070G-38S	\$53.26
7	240	1000	HT37070A-14S	\$44.38	HT37070A-26S	\$48.82	HT37070A-38S	\$53.26
7.5	240	500	HT37075A-14S	\$44.38	HT37075A-26S	\$48.82	HT37075A-38S	\$53.26
8	120	250	HT37080A-14S	\$47.88	HT37080A-26S	\$52.32	HT37080A-38S	\$56.76
8	120	300	HT37080C-14S	\$47.88	HT37080C-26S	\$52.32	HT37080C-38S	\$56.76
8	240	300	HT37080D-14S	\$47.88	HT37080D-26S	\$52.32	HT37080D-38S	\$56.76
8	120	500	HT37080E-14S	\$47.88	HT37080E-26S	\$52.32	HT37080E-38S	\$56.76
8	240	500	HT37080F-14S	\$47.88	HT37080F-26S	\$52.32	HT37080F-38S	\$56.76
8	120	600	HT37080H-14S	\$47.88	HT37080H-26S	\$52.32	HT37080H-38S	\$56.76
8	240	600	HT37080B-14S	\$47.88	HT37080B-26S	\$52.32	HT37080B-38S	\$56.76
8	240	750	HT37080G-14S	\$47.88	HT37080G-26S	\$52.32	HT37080G-38S	\$56.76
8	240	1000	HT37080A-14S	\$47.88	HT37080A-26S	\$52.32	HT37080A-38S	\$56.76
9	120	250	HT37090A-14S	\$51.43	HT37090A-26S	\$55.87	HT37090A-38S	\$60.31
9	120	400	HT37090B-14S	\$51.43	HT37090B-26S	\$55.87	HT37090B-38S	\$60.31
9	240	400	HT37090C-14S	\$51.43	HT37090C-26S	\$55.87	HT37090C-38S	\$60.31
9	240	1000	HT37090A-14S	\$51.43	HT37090A-26S	\$55.87	HT37090A-38S	\$60.31
10	120	250	HT37100A-14S	\$54.98	HT37100A-26S	\$59.42	HT37100A-38S	\$63.86
10	120	400	HT37100C-14S	\$54.98	HT37100C-26S	\$59.42	HT37100C-38S	\$63.86
10	120	600	HT37100D-14S	\$54.98	HT37100D-26S	\$59.42	HT37100D-38S	\$63.86
10	240	600	HT37100B-14S	\$54.98	HT37100B-26S	\$59.42	HT37100B-38S	\$63.86
10	240	1000	HT37100A-14S	\$54.98	HT37100A-26S	\$59.42	HT37100A-38S	\$63.86
11	240	1000	HT37110A-14S	\$58.48	HT37110A-26S	\$62.92	HT37110A-38S	\$67.36
12	120	250	HT37120A-14S	\$62.03	HT37120A-26S	\$66.47	HT37120A-38S	\$70.91
12	120	500	HT37120D-14S	\$62.03	HT37120D-26S	\$66.47	HT37120D-38S	\$70.91
12	240	500	HT37120E-14S	\$62.03	HT37120E-26S	\$66.47	HT37120E-38S	\$70.91
12	120	600	HT37120F-14S	\$62.03	HT37120F-26S	\$66.47	HT37120F-38S	\$70.91
12	240	600	HT37120B-14S	\$62.03	HT37120B-26S	\$66.47	HT37120B-38S	\$70.91
12	240	750	HT37120G-14S	\$62.03	HT37120G-26S	\$66.47	HT37120G-38S	\$70.91
12	240	1000	HT37120A-14S	\$62.03	HT37120A-26S	\$66.47	HT37120A-38S	\$70.91
12	240	1500	HT37120C-14S	\$62.03	HT37120C-26S	\$66.47	HT37120C-38S	\$70.91

Stock .375" Diameter Heaters (Continued)

LENGTH	VOLTS	WATTS	14" LEADS	PRICE	26" LEADS	PRICE	38" LEADS	PRICE
14	240	600	HT37140A-14S	\$69.13	HT37140A-26S	\$73.57	HT37140A-38S	\$78.01
14	240	1000	HT37140B-14S	\$69.13	HT37140B-26S	\$73.57	HT37140B-38S	\$78.01
15	240	1000	HT37150A-14S	\$72.68	HT37150A-26S	\$77.12	HT37150A-38S	\$81.56
16	240	1000	HT37160A-14S	\$76.28	HT37160A-26S	\$80.72	HT37160A-38S	\$85.16
21	240	1000	HT37210A-14S	\$94.03	HT37210A-26S	\$98.47	HT37210A-38S	\$102.91

Do not see what you need?

We can build to your specifications!

.375" Diameter Options Selection

Lead Options



Price	No Additional Charge
-------	----------------------

Solid Nickel Pins

Utilized in high heat applications and where there is no movement or vibration. Lead wires can be added via exterior crimps. Damaged wires can be replaced quickly.



Price	First 14"	Per Additional 12"
	No Charge	\$2.79

Fiberglass Leads (Standard)

Pure nickel conductors insulated with 950°F fiberglass insulation.



Price	First 14"	Per Additional 12"
	\$3.73	\$1.89

Silicon Leads

Ideal for high movement applications where there is limited heat. Can withstand temperatures up to 450°F. Provides limited protection to moisture. Requires Silicon Potting to be utilized.



Price	First 14"	Per Additional 12"
	\$3.73	\$1.89

Teflon Leads

Ideal for excessive movement and high vibration applications. Can withstand moderate temperatures 450°F. Provides limited protection from moisture. Requires either silicon potting or a Teflon seal.

.375" Diameter Options Selection

Lead Protection Options



Price	First 12"	Per Additional 12"
	\$3.99	\$1.78

Fiberglass Sleeving

Protection against temperatures up to 950°F while providing moderate protection against friction.



Price	First 12"	Per additional 12"
	\$9.89	\$4.15

Braided Metal Sleeving (BMS)

Ideal for high friction and constant bending. Stainless steel construction with high flexibility.



Price	First 12"	Per additional 12"
	\$13.25	\$5.55

Armor Conduit

Water resistant interlocking design allows for limited exposure to moisture. Flexibility allows an added level of protection against physical damage to the lead wires.

All options can be added to stock items and shipped within 24 hours of ordering!

.375" Diameter Options Selection

NPT Fittings

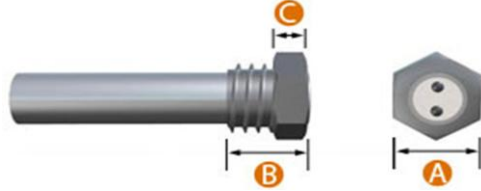

	Stainless Steel	Brass
Price	\$15.89	\$13.97

Specifications	3/8" Diameter
A	.590"
B	.750"
C	.250"
NPT Fitting	1/4

Right Angle Block Exit with Knockout Tab

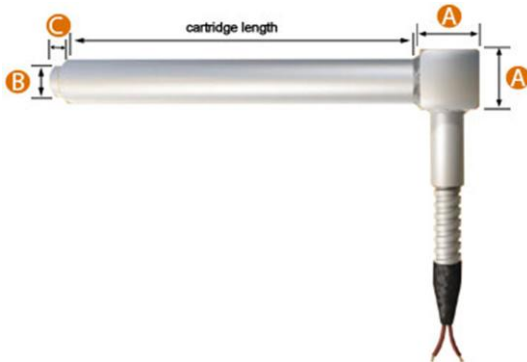

Specifications	
A	.475"
B	.355"
C	.157"

	Right Angle Block	Knockout Tab
Price	\$19.20	\$6.73

All options can be added to stock items and shipped within 24 hours of ordering!

.375" Diameter Options Selection

Optional Exit Styles

Right Angle Exit

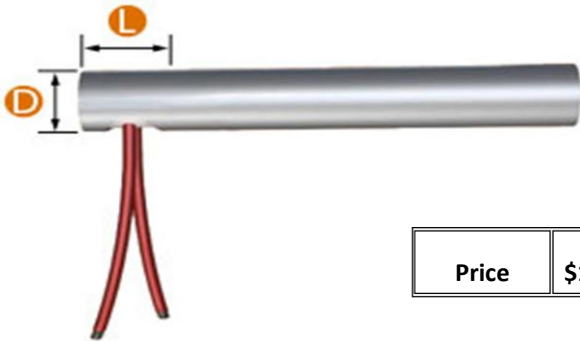

Price	\$11.80
-------	---------

Specifications	
D	.375"
L	.625"

Right Angle Exit with Stress Relief Tube

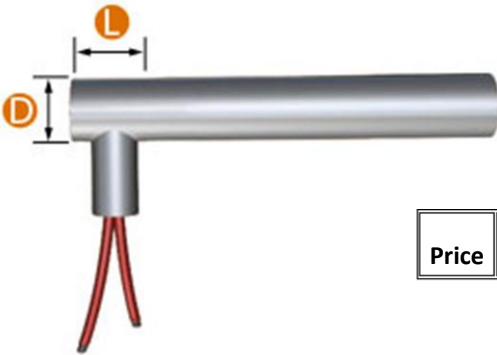

Price	\$13.80
-------	---------

Specifications	
D	.375"
L	.625"

Right Angle Elbow

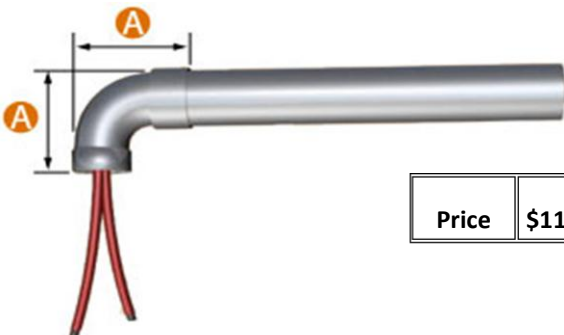

Price	\$11.80
-------	---------

Specifications	
A	.625"

All options can be added to stock items and shipped within 24 hours of ordering!

Stock .5" Diameter Heaters

LENGTH	VOLTS	WATTS	14" LEADS	PRICE	26" LEADS	PRICE	38" LEADS	PRICE
1.5	120	50	HT50015A-14S	\$25.94	HT50015A-26S	\$30.42	HT50015A-38S	\$34.86
1.5	120	200	HT50015B-14S	\$25.94	HT50015B-26S	\$30.42	HT50015B-38S	\$34.86
1.5	240	200	HT50015A-14S	\$25.94	HT50015A-26S	\$30.42	HT50015A-38S	\$34.86
2	120	75	HT50020A-14S	\$30.64	HT50020A-26S	\$35.12	HT50020A-38S	\$39.56
2	120	100	HT50020B-14S	\$30.64	HT50020B-26S	\$35.12	HT50020A-38S	\$39.56
2	240	200	HT50020C-14S	\$30.64	HT50020C-26S	\$35.12	HT50020C-38S	\$39.56
2	240	300	HT50020A-14S	\$30.64	HT50020A-26S	\$35.12	HT50020A-38S	\$39.56
2	240	400	HT50020B-14S	\$30.64	HT50020B-26S	\$35.12	HT50020B-38S	\$39.56
2.5	120	75	HT50025A-14S	\$30.64	HT50025A-26S	\$35.12	HT50025A-38S	\$39.56
2.5	120	100	HT50025B-14S	\$30.64	HT50025B-26S	\$35.12	HT50025B-38S	\$39.56
2.5	120	125	HT50025C-14S	\$30.64	HT50025C-26S	\$35.12	HT50025C-38S	\$39.56
2.5	240	300	HT50025A-14S	\$30.64	HT50025A-26S	\$35.12	HT50025A-38S	\$39.56
2.5	240	400	HT50025B-14S	\$30.64	HT50025B-26S	\$35.12	HT50025B-38S	\$39.56
2.5	240	500	HT50025C-14S	\$30.64	HT50025C-26S	\$35.12	HT50025C-38S	\$39.56
3	120	100	HT50030F-14S	\$35.34	HT50030F-26S	\$39.82	HT50030F-38S	\$44.26
3	120	125	HT50030G-14S	\$35.34	HT50030G-26S	\$39.82	HT50030G-38S	\$44.26
3	240	125	HT50030A-14S	\$35.34	HT50030A-26S	\$39.82	HT50030A-38S	\$44.26
3	120	250	HT50030B-14S	\$35.34	HT50030B-26S	\$39.82	HT50030B-38S	\$44.26
3	240	250	HT50030C-14S	\$35.34	HT50030C-26S	\$39.82	HT50030C-38S	\$44.26
3	120	300	HT50030H-14S	\$35.34	HT50030H-26S	\$39.82	HT50030H-38S	\$44.26
3	240	300	HT50030D-14S	\$35.34	HT50030D-26S	\$39.82	HT50030D-38S	\$44.26
3	120	400	HT50030E-14S	\$35.34	HT50030E-26S	\$39.82	HT50030E-38S	\$44.26
3	240	400	HT50030F-14S	\$35.34	HT50030F-26S	\$39.82	HT50030F-38S	\$44.26
3	120	500	HT50030J-14S	\$35.34	HT50030J-26S	\$39.82	HT50030J-38S	\$44.26
3	240	500	HT50030A-14S	\$35.34	HT50030A-26S	\$39.82	HT50030A-38S	\$44.26
3.5	120	125	HT50035A-14S	\$35.34	HT50035A-26S	\$39.82	HT50035A-38S	\$44.26
3.5	240	250	HT50035B-14S	\$35.34	HT50035B-26S	\$39.82	HT50035B-38S	\$44.26
3.5	240	400	HT50035C-14S	\$35.34	HT50035C-26S	\$39.82	HT50035C-38S	\$44.26
3.5	240	500	HT50035A-14S	\$35.34	HT50035A-26S	\$39.82	HT50035A-38S	\$44.26
3.5	240	750	HT50035D-14S	\$35.34	HT50035D-26S	\$39.82	HT50035D-38S	\$44.26
4	240	125	HT50040A-14S	\$40.04	HT50040A-26S	\$44.52	HT50040A-38S	\$48.96

Stock .5" Diameter Heaters (Continued)

LENGTH	VOLTS	WATTS	14" LEADS	PRICE	26" LEADS	PRICE	38" LEADS	PRICE
4	120	150	HT50040M-14S	\$40.04	HT50040M-26S	\$44.52	HT50040M-38S	\$48.96
4	120	200	HT50040J-14S	\$40.04	HT50040J-26S	\$44.52	HT50040J-38S	\$48.96
4	120	250	HT50040K-14S	\$40.04	HT50040K-26S	\$44.52	HT50040K-38S	\$48.96
4	240	250	HT50040B-14S	\$40.04	HT50040B-26S	\$44.52	HT50040B-38S	\$48.96
4	120	300	HT50040C-14S	\$40.04	HT50040C-26S	\$44.52	HT50040C-38S	\$48.96
4	240	300	HT50040D-14S	\$40.04	HT50040D-26S	\$44.52	HT50040D-38S	\$48.96
4	120	400	HT50040E-14S	\$40.04	HT50040E-26S	\$44.52	HT50040E-38S	\$48.96
4	240	400	HT50040F-14S	\$40.04	HT50040F-26S	\$44.52	HT50040F-38S	\$48.96
4	120	500	HT50040L-14S	\$40.04	HT50040L-26S	\$44.52	HT50040L-38S	\$48.96
4	240	500	HT50040G-14S	\$40.04	HT50040G-26S	\$44.52	HT50040G-38S	\$48.96
4	240	600	HT50040M-14S	\$40.04	HT50040M-26S	\$44.52	HT50040M-38S	\$48.96
4	240	750	HT50040H-14S	\$40.04	HT50040H-26S	\$44.52	HT50040H-38S	\$48.96
4	240	800	HT50040J-14S	\$40.04	HT50040J-26S	\$44.52	HT50040J-38S	\$48.96
4	240	1000	HT50040K-14S	\$40.04	HT50040K-26S	\$44.52	HT50040K-38S	\$48.96
4.5	120	125	HT50045C-14S	\$40.04	HT50045C-26S	\$44.52	HT50045C-38S	\$48.96
4.5	120	175	HT50045B-14S	\$40.04	HT50045B-26S	\$44.52	HT50045B-38S	\$48.96
4.5	240	250	HT50045A-14S	\$40.04	HT50045A-26S	\$44.52	HT50045A-38S	\$48.96
4.5	240	500	HT50045C-14S	\$40.04	HT50045C-26S	\$44.52	HT50045C-38S	\$48.96
4.5	240	750	HT50045B-14S	\$40.04	HT50045B-26S	\$44.52	HT50045B-38S	\$48.96
5	120	200	HT50050A-14S	\$44.69	HT50050A-26S	\$49.17	HT50050A-38S	\$53.61
5	120	250	HT50050B-14S	\$44.69	HT50050B-26S	\$49.17	HT50050B-38S	\$53.61
5	240	250	HT50050F-14S	\$44.69	HT50050F-26S	\$49.17	HT50050F-38S	\$53.61
5	240	300	HT50050C-14S	\$44.69	HT50050C-26S	\$49.17	HT50050C-38S	\$53.61
5	120	500	HT50050D-14S	\$44.69	HT50050D-26S	\$49.17	HT50050D-38S	\$53.61
5	240	500	HT50050E-14S	\$44.69	HT50050E-26S	\$49.17	HT50050E-38S	\$53.61
5	240	800	HT50050A-14S	\$44.69	HT50050A-26S	\$49.17	HT50050A-38S	\$53.61
5	240	1000	HT50050B-14S	\$44.69	HT50050B-26S	\$49.17	HT50050B-38S	\$53.61
5.5	240	500	HT50055B-14S	\$44.69	HT50055B-26S	\$49.17	HT50055B-38S	\$53.61
5.5	240	750	HT50055A-14S	\$44.69	HT50055A-26S	\$49.17	HT50055A-38S	\$53.61
6	120	250	HT50060D-14S	\$49.39	HT50060D-26S	\$53.87	HT50060D-38S	\$58.31
6	240	250	HT50060E-14S	\$49.39	HT50060E-26S	\$53.87	HT50060E-38S	\$58.31
6	120	300	HT50060G-14S	\$49.39	HT50060G-26S	\$53.87	HT50060G-38S	\$58.31
6	240	300	HT50060H-14S	\$49.39	HT50060H-26S	\$53.87	HT50060H-38S	\$58.31

Stock .5" Diameter Heaters (Continued)

LENGTH	VOLTS	WATTS	14" LEADS	PRICE	26" LEADS	PRICE	38" LEADS	PRICE
6	120	375	HT50060A-14S	\$49.39	HT50060A-26S	\$53.87	HT50060A-38S	\$58.31
6	240	400	HT50060J-14S	\$49.39	HT50060J-26S	\$53.87	HT50060J-38S	\$58.31
6	120	500	HT50060K-14S	\$49.39	HT50060K-26S	\$53.87	HT50060K-38S	\$58.31
6	240	500	HT50060B-14S	\$49.39	HT50060B-26S	\$53.87	HT50060B-38S	\$58.31
6	240	750	HT50060C-14S	\$49.39	HT50060C-26S	\$53.87	HT50060C-38S	\$58.31
6	120	1000	HT50060F-14S	\$49.39	HT50060F-26S	\$53.87	HT50060F-38S	\$58.31
6	240	1000	HT50060D-14S	\$49.39	HT50060D-26S	\$53.87	HT50060D-38S	\$58.31
6	240	1200	HT50060G-14S	\$49.39	HT50060G-26S	\$53.87	HT50060G-38S	\$58.31
6	240	1500	HT50060A-14S	\$49.39	HT50060A-26S	\$53.87	HT50060A-38S	\$58.31
6.5	120	250	HT50065A-14S	\$49.39	HT50065A-26S	\$53.87	HT50065A-38S	\$58.31
6.5	240	500	HT50065B-14S	\$49.39	HT50065B-26S	\$53.87	HT50065B-38S	\$58.31
6.5	240	1000	HT50065A-14S	\$49.39	HT50065A-26S	\$53.87	HT50065A-38S	\$58.31
7	120	250	HT50070A-14S	\$54.09	HT50070A-26S	\$58.57	HT50070A-38S	\$63.01
7	240	300	HT50070D-14S	\$54.09	HT50070D-26S	\$58.57	HT50070D-38S	\$63.01
7	120	500	HT50070E-14S	\$54.09	HT50070E-26S	\$58.57	HT50070E-38S	\$63.01
7	240	500	HT50070F-14S	\$54.09	HT50070F-26S	\$58.57	HT50070F-38S	\$63.01
7	120	600	HT50070B-14S	\$54.09	HT50070B-26S	\$58.57	HT50070B-38S	\$63.01
7	240	600	HT50070C-14S	\$54.09	HT50070C-26S	\$58.57	HT50070C-38S	\$63.01
7	240	750	HT50070G-14S	\$54.09	HT50070G-26S	\$58.57	HT50070G-38S	\$63.01
7	240	1000	HT50070A-14S	\$54.09	HT50070A-26S	\$58.57	HT50070A-38S	\$63.01
7.5	240	1000	HT50075A-14S	\$54.09	HT50075A-26S	\$58.57	HT50075A-38S	\$63.01
8	120	250	HT50080G-14S	\$58.74	HT50080G-26S	\$63.22	HT50080G-38S	\$67.66
8	240	250	HT50080K-14S	\$58.74	HT50080K-26S	\$63.22	HT50080K-38S	\$67.66
8	120	300	HT50080H-14S	\$58.74	HT50080H-26S	\$63.22	HT50080H-38S	\$67.66
8	120	375	HT50080A-14S	\$58.74	HT50080A-26S	\$63.22	HT50080A-38S	\$67.66
8	240	400	HT50080B-14S	\$58.74	HT50080B-26S	\$63.22	HT50080B-38S	\$67.66
8	120	500	HT50080J-14S	\$58.74	HT50080J-26S	\$63.22	HT50080J-38S	\$67.66
8	240	500	HT50080C-14S	\$58.74	HT50080C-26S	\$63.22	HT50080C-38S	\$67.66
8	120	750	HT50080D-14S	\$58.74	HT50080D-26S	\$63.22	HT50080D-38S	\$67.66
8	240	750	HT50080E-14S	\$58.74	HT50080E-26S	\$63.22	HT50080E-38S	\$67.66
8	120	1000	HT50080F-14S	\$58.74	HT50080F-26S	\$63.22	HT50080F-38S	\$67.66
8	240	1000	HT50080G-14S	\$58.74	HT50080G-26S	\$63.22	HT50080G-38S	\$67.66
8	480	1000	HT50080K-14S	\$58.74	HT50080K-26S	\$63.22	HT50080K-38S	\$67.66

Stock .5" Diameter Heaters (Continued)

LENGTH	VOLTS	WATTS	14" LEADS	PRICE	26" LEADS	PRICE	38" LEADS	PRICE
8	240	1200	HT50080H-14S	\$58.74	HT50080H-26S	\$63.22	HT50080H-38S	\$67.66
8	240	1500	HT50080A-14S	\$58.74	HT50080A-26S	\$63.22	HT50080A-38S	\$67.66
8	240	2000	HT50080J-14S	\$58.74	HT50080J-26S	\$63.22	HT50080J-38S	\$67.66
8.5	240	500	HT50085A-14S	\$58.74	HT50085A-26S	\$63.22	HT50085A-38S	\$67.66
8.5	240	1000	HT50085B-14S	\$58.74	HT50085B-26S	\$63.22	HT50085B-38S	\$67.66
9	240	500	HT50090A-14S	\$63.44	HT50090A-26S	\$67.92	HT50090A-38S	\$72.36
9	240	1000	HT50090B-14S	\$63.44	HT50090B-26S	\$67.92	HT50090B-38S	\$72.36
9.5	240	1000	HT50095A-14S	\$63.44	HT50095A-26S	\$67.92	HT50095A-38S	\$72.36
10	120	500	HT50100A-14S	\$68.14	HT50100A-26S	\$72.62	HT50100A-38S	\$77.06
10	240	500	HT50100B-14S	\$68.14	HT50100B-26S	\$72.62	HT50100B-38S	\$77.06
10	240	600	HT50100F-14S	\$68.14	HT50100F-26S	\$72.62	HT50100F-38S	\$77.06
10	120	1000	HT50100C-14S	\$68.14	HT50100C-26S	\$72.62	HT50100C-38S	\$77.06
10	240	1000	HT50100D-14S	\$68.14	HT50100D-26S	\$72.62	HT50100D-38S	\$77.06
10	480	1000	HT50100G-14S	\$68.14	HT50100G-26S	\$72.62	HT50100G-38S	\$77.06
10	240	1500	HT50100E-14S	\$68.14	HT50100E-26S	\$72.62	HT50100E-38S	\$77.06
10	240	2000	HT50100A-14S	\$68.14	HT50100A-26S	\$72.62	HT50100A-38S	\$77.06
10	480	2000	HT50100H-14S	\$68.14	HT50100H-26S	\$72.62	HT50100H-38S	\$77.06
11	240	1000	HT50110A-14S	\$72.84	HT50110A-26S	\$77.32	HT50110A-38S	\$81.76
11	240	1600	HT50110B-14S	\$72.84	HT50110B-26S	\$77.32	HT50110B-38S	\$81.76
12	120	500	HT50120A-14S	\$77.49	HT50120A-26S	\$81.97	HT50120A-38S	\$86.41
12	240	500	HT50120E-14S	\$77.49	HT50120E-26S	\$81.97	HT50120E-38S	\$86.41
12	120	600	HT50120F-14S	\$77.49	HT50120F-26S	\$81.97	HT50120F-38S	\$86.41
12	240	600	HT50120B-14S	\$77.49	HT50120B-26S	\$81.97	HT50120B-38S	\$86.41
12	240	800	HT50120G-14S	\$77.49	HT50120G-26S	\$81.97	HT50120G-38S	\$86.41
12	120	1000	HT50120H-14S	\$77.49	HT50120H-26S	\$81.97	HT50120H-38S	\$86.41
12	240	1000	HT50120C-14S	\$77.49	HT50120C-26S	\$81.97	HT50120C-38S	\$86.41
12	480	1200	HT50120J-14S	\$77.49	HT50120J-26S	\$81.97	HT50120J-38S	\$86.41
12	240	1500	HT50120D-14S	\$77.49	HT50120D-26S	\$81.97	HT50120D-38S	\$86.41
12	240	2000	HT50120A-14S	\$77.49	HT50120A-26S	\$81.97	HT50120A-38S	\$86.41
12	240	2400	HT50120F-14S	\$77.49	HT50120F-26S	\$81.97	HT50120F-38S	\$86.41
12.5	240	1000	HT50125A-14S	\$77.49	HT50125A-26S	\$81.97	HT50125A-38S	\$86.41
13	240	1000	HT50130A-14S	\$82.19	HT50130A-26S	\$86.67	HT50130A-38S	\$91.11
14	120	1000	HT50140A-14S	\$86.89	HT50140A-26S	\$91.37	HT50140A-38S	\$95.81

Stock .5" Diameter Heaters (Continued)

LENGTH	VOLTS	WATTS	14" LEADS	PRICE	26" LEADS	PRICE	38" LEADS	PRICE
14	240	1000	HT50140B-14S	\$86.89	HT50140B-26S	\$91.37	HT50140B-38S	\$95.81
14	240	2300	HT50140C-14S	\$86.89	HT50140C-26S	\$91.37	HT50140C-38S	\$95.81
15	240	1000	HT50150A-14S	\$91.59	HT50150A-26S	\$96.07	HT50150A-38S	\$100.51
15	240	1500	HT50150B-14S	\$91.59	HT50150B-26S	\$96.07	HT50150B-38S	\$100.51
15	240	2000	HT50150C-14S	\$91.59	HT50150C-26S	\$96.07	HT50150C-38S	\$100.51
16	120	800	HT50160A-14S	\$96.24	HT50160A-26S	\$100.72	HT50160A-38S	\$105.16
16	240	800	HT50160B-14S	\$96.24	HT50160B-26S	\$100.72	HT50160B-38S	\$105.16
16	240	1000	HT50160C-14S	\$96.24	HT50160C-26S	\$100.72	HT50160C-38S	\$105.16
16	240	1500	HT50160D-14S	\$96.24	HT50160D-26S	\$100.72	HT50160D-38S	\$105.16
16	240	2000	HT50160E-14S	\$96.24	HT50160E-26S	\$100.72	HT50160E-38S	\$105.16
18	240	1000	HT50180A-14S	\$105.64	HT50180A-26S	\$110.12	HT50180A-38S	\$114.56
18	240	1500	HT50180C-14S	\$105.64	HT50180C-26S	\$110.12	HT50180C-38S	\$114.56
18	480	1500	HT50180B-14S	\$105.64	HT50180B-26S	\$110.12	HT50180B-38S	\$114.56
20	240	1000	HT50200A-14S	\$110.34	HT50200A-26S	\$114.82	HT50200A-38S	\$119.26
20	240	1500	HT50200B-14S	\$110.34	HT50200B-26S	\$114.82	HT50200B-38S	\$119.26
24	240	1000	HT50240A-14S	\$133.74	HT50240A-26S	\$138.22	HT50240A-38S	\$142.66
24	240	2000	HT50240B-14S	\$133.74	HT50240B-26S	\$138.22	HT50240B-38S	\$142.66

Do not see what you need?

We can build to your specifications!

.5" Diameter Options Selection

Lead Options



Price	No Additional Charge
-------	----------------------

Solid Nickel Pins

Utilized in high heat applications and where there is no movement or vibration. Lead wires can be added via exterior crimps. Damaged wires can be replaced quickly.



Price	First 14"	Per Additional 12"
	No Charge	\$2.79

Fiberglass Leads (Standard)

Pure nickel conductors insulated with 950°F fiberglass insulation.



Price	First 14"	Per Additional 12"
	\$3.73	\$1.89

Silicon Leads

Ideal for high movement applications where there is limited heat. Can withstand temperatures up to 450°F. Provides limited protection to moisture. Requires Silicon Potting to be utilized.



Price	First 14"	Per Additional 12"
	\$3.73	\$1.89

Teflon Leads

Ideal for excessive movement and high vibration applications. Can withstand moderate temperatures 450°F. Provides limited protection from moisture. Requires either silicon potting or a Teflon seal.

.5" Diameter Options Selection

Lead Protection Options



Price	First 12"	Per Additional 12"
	\$3.99	\$1.78

Fiberglass Sleeving

Protection against high temperatures up to 950°F while providing moderate protection against friction.



Price	First 12"	Per Additional 12"
	\$9.89	\$4.15

Braided Metal Sleeving (BMS)

Ideal for high friction and constant bending. Stainless steel construction with high flexibility.



Price	First 12"	Per Additional 12"
	\$13.25	\$5.55

Armor Conduit

Water resistant interlocking design allows for limited exposure to moisture. Flexibility allows an added level of protection against physical damage to the lead wires.

All options can be added to stock items and shipped within 24 hours of ordering!

.5" Diameter Options Selection

NPT Fittings

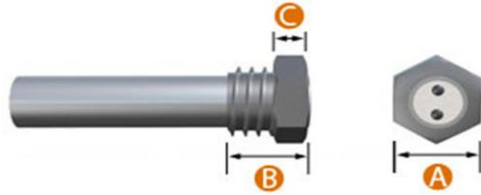

	Stainless Steel	Brass
Price	\$17.89	\$15.97

Specifications	.500" Diameter
A	.675"
B	.750"
C	.250"
NPT Fitting	3/8

Right Angle Block Exit with Knockout Tab

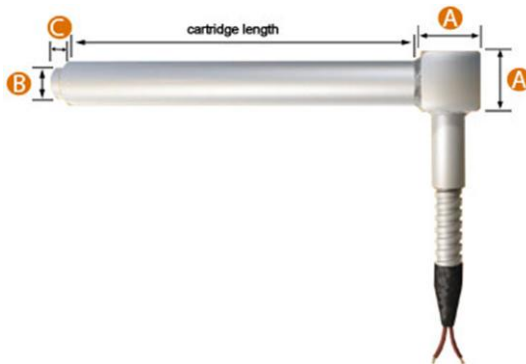

Specifications	
A	.550"
B	.355"
C	.157"

	Right Angle Block	Knockout Tab
Price	\$19.20	\$8.73

All options can be added to stock items and shipped within 24 hours of ordering!

.5" Diameter Options Selection

Optional Exit Styles

Right Angle Exit

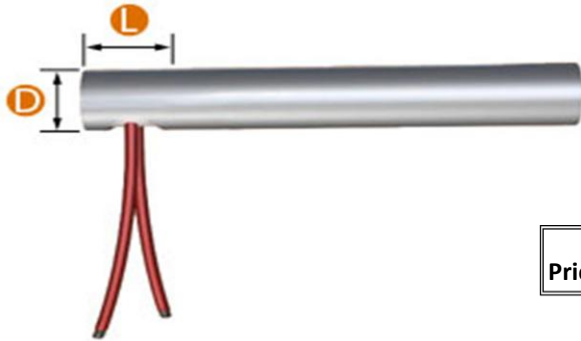

Price \$11.80

Specifications	
D	.500"
L	.625"

Right Angle Exit with Stress Relief Tube

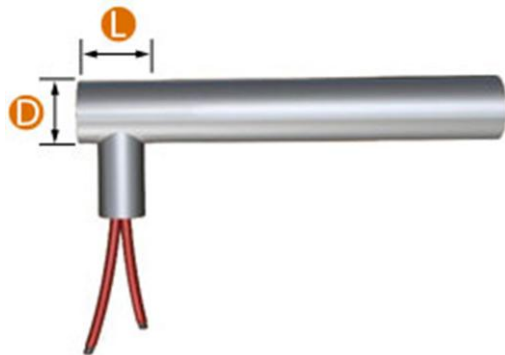

Price \$13.80

Specifications	
D	.500"
L	.625"

Right Angle Elbow

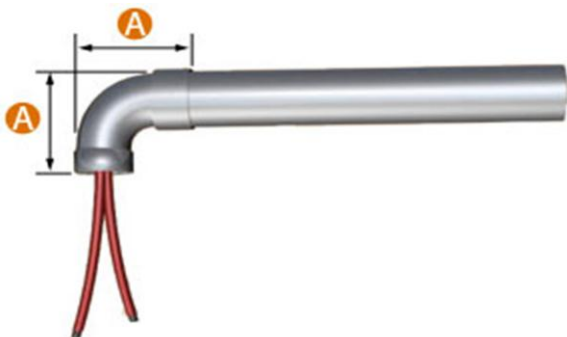

Price \$11.80

Specifications	
A	.75"

All options can be added to stock items and shipped within 24 hours of ordering!

Stock .625" Diameter Heaters

LENGTH	VOLTS	WATTS	14" LEADS	PRICE	26" LEADS	PRICE	38" LEADS	PRICE
3	240	250	HT62030A-14S	\$38.23	HT62030A-26S	\$43.87	HT62030A-38S	\$49.51
3	240	400	HT62030B-14S	\$38.23	HT62030B-26S	\$43.87	HT62030B-38S	\$49.51
3	120	500	HT62030D-14S	\$38.23	HT62030D-26S	\$43.87	HT62030D-38S	\$49.51
3	240	500	HT62030C-14S	\$38.23	HT62030C-26S	\$43.87	HT62030C-38S	\$49.51
4	120	250	HT62040A-14S	\$43.43	HT62040A-26S	\$49.07	HT62040A-38S	\$54.71
4	240	500	HT62040B-14S	\$43.43	HT62040B-26S	\$49.07	HT62040B-38S	\$54.71
4	240	750	HT62040C-14S	\$43.43	HT62040C-26S	\$49.07	HT62040C-38S	\$54.71
4	240	1000	HT62040A-14S	\$43.43	HT62040A-26S	\$49.07	HT62040A-38S	\$54.71
5	120	250	HT62050A-14S	\$48.64	HT62050A-26S	\$54.28	HT62050A-38S	\$59.92
5	240	500	HT62050B-14S	\$48.64	HT62050B-26S	\$54.28	HT62050B-38S	\$59.92
5	240	750	HT62050C-14S	\$48.64	HT62050C-26S	\$54.28	HT62050C-38S	\$59.92
5	240	1000	HT62050A-14S	\$48.64	HT62050A-26S	\$54.28	HT62050A-38S	\$59.92
6	120	250	HT62060A-14S	\$53.83	HT62060A-26S	\$59.47	HT62060A-38S	\$65.11
6	120	375	HT62060D-14S	\$53.83	HT62060D-26S	\$59.47	HT62060D-38S	\$65.11
6	120	500	HT62060F-14S	\$53.83	HT62060F-26S	\$59.47	HT62060F-38S	\$65.11
6	240	500	HT62060B-14S	\$53.83	HT62060B-26S	\$59.47	HT62060B-38S	\$65.11
6	120	750	HT62060G-14S	\$53.83	HT62060G-26S	\$59.47	HT62060G-38S	\$65.11
6	240	750	HT62060C-14S	\$53.83	HT62060C-26S	\$59.47	HT62060C-38S	\$65.11
6	240	1000	HT62060A-14S	\$53.83	HT62060A-26S	\$59.47	HT62060A-38S	\$65.11
6	240	1500	HT62060D-14S	\$53.83	HT62060D-26S	\$59.47	HT62060D-38S	\$65.11
7	120	375	HT62070A-14S	\$59.03	HT62070A-26S	\$64.67	HT62070A-38S	\$70.31
7	240	500	HT62070C-14S	\$59.03	HT62070C-26S	\$64.67	HT62070C-38S	\$70.31
7	240	1000	HT62070B-14S	\$59.03	HT62070B-26S	\$64.67	HT62070B-38S	\$70.31
7	240	1500	HT62070A-14S	\$59.03	HT62070A-26S	\$64.67	HT62070A-38S	\$70.31
8	120	375	HT62080C-14S	\$64.23	HT62080C-26S	\$69.87	HT62080C-38S	\$75.51
8	120	500	HT62080D-14S	\$64.23	HT62080D-26S	\$69.87	HT62080D-38S	\$75.51
8	240	500	HT62080A-14S	\$64.23	HT62080A-26S	\$69.87	HT62080A-38S	\$75.51
8	240	750	HT62080E-14S	\$64.23	HT62080E-26S	\$69.87	HT62080E-38S	\$75.51
8	240	1000	HT62080B-14S	\$64.23	HT62080B-26S	\$69.87	HT62080B-38S	\$75.51
8	240	1500	HT62080C-14S	\$64.23	HT62080C-26S	\$69.87	HT62080C-38S	\$75.51
8	240	2000	HT62080D-14S	\$64.23	HT62080D-26S	\$69.87	HT62080D-38S	\$75.51

Stock .625" Diameter Heaters (Continued)

LENGTH	VOLTS	WATTS	14" LEADS	PRICE	26" LEADS	PRICE	38" LEADS	PRICE
9	240	1000	HT62090A-14S	\$69.43	HT62090A-26S	\$75.07	HT62090A-38S	\$80.71
9	240	1500	HT62090B-14S	\$69.43	HT62090B-26S	\$75.07	HT62090B-38S	\$80.71
10	120	500	HT62100A-14S	\$74.63	HT62100A-26S	\$80.27	HT62100A-38S	\$85.91
10	240	500	HT62100E-14S	\$74.63	HT62100E-26S	\$80.27	HT62100E-38S	\$85.91
10	240	650	HT62100B-14S	\$74.63	HT62100B-26S	\$80.27	HT62100B-38S	\$85.91
10	240	750	HT62100F-14S	\$74.63	HT62100F-26S	\$80.27	HT62100F-38S	\$85.91
10	240	1000	HT62100C-14S	\$74.63	HT62100C-26S	\$80.27	HT62100C-38S	\$85.91
10	240	1500	HT62100D-14S	\$74.63	HT62100D-26S	\$80.27	HT62100D-38S	\$85.91
10	240	2000	HT62100A-14S	\$74.63	HT62100A-26S	\$80.27	HT62100A-38S	\$85.91
11	240	1000	HT62110A-14S	\$79.83	HT62110A-26S	\$85.47	HT62110A-38S	\$91.11
12	120	500	HT62120C-14S	\$85.08	HT62120C-26S	\$90.72	HT62120C-38S	\$96.36
12	240	500	HT62120D-14S	\$85.08	HT62120D-26S	\$90.72	HT62120D-38S	\$96.36
12	240	1000	HT62120A-14S	\$85.08	HT62120A-26S	\$90.72	HT62120A-38S	\$96.36
12	240	1500	HT62120B-14S	\$85.08	HT62120B-26S	\$90.72	HT62120B-38S	\$96.36
12	480	1500	HT62120E-14S	\$85.08	HT62120E-26S	\$90.72	HT62120E-38S	\$96.36
12	240	2000	HT62120C-14S	\$85.08	HT62120C-26S	\$90.72	HT62120C-38S	\$96.36
12	480	2000	HT62120D-14S	\$85.08	HT62120D-26S	\$90.72	HT62120D-38S	\$96.36
13	240	1000	HT62130A-14S	\$90.28	HT62130A-26S	\$95.92	HT62130A-38S	\$101.56
14	120	500	HT62140C-14S	\$95.48	HT62140C-26S	\$101.12	HT62140C-38S	\$106.76
14	240	1000	HT62140A-14S	\$95.48	HT62140A-26S	\$101.12	HT62140A-38S	\$106.76
14	240	1500	HT62140B-14S	\$95.48	HT62140B-26S	\$101.12	HT62140B-38S	\$106.76
14	240	2000	HT62140C-14S	\$95.48	HT62140C-26S	\$101.12	HT62140C-38S	\$106.76
15	120	500	HT62150A-14S	\$100.68	HT62150A-26S	\$106.32	HT62150A-38S	\$111.96
15	120	600	HT62150B-14S	\$100.68	HT62150B-26S	\$106.32	HT62150B-38S	\$111.96
15	240	750	HT62150C-14S	\$100.68	HT62150C-26S	\$106.32	HT62150C-38S	\$111.96
15	240	1000	HT62150D-14S	\$100.68	HT62150D-26S	\$106.32	HT62150D-38S	\$111.96
15	240	2000	HT62150A-14S	\$100.68	HT62150A-26S	\$106.32	HT62150A-38S	\$111.96
15	240	2400	HT62150B-14S	\$100.68	HT62150B-26S	\$106.32	HT62150B-38S	\$111.96
16	120	500	HT62160B-14S	\$105.88	HT62160B-26S	\$111.52	HT62160B-38S	\$117.16
16	120	625	HT62160C-14S	\$105.88	HT62160C-26S	\$111.52	HT62160C-38S	\$117.16
16	240	1000	HT62160A-14S	\$105.88	HT62160A-26S	\$111.52	HT62160A-38S	\$117.16
16	120	1125	HT62160D-14S	\$105.88	HT62160D-26S	\$111.52	HT62160D-38S	\$117.16
16	240	2000	HT62160B-14S	\$105.88	HT62160B-26S	\$111.52	HT62160B-38S	\$117.16

Stock .625" Diameter Heaters (Continued)

LENGTH	VOLTS	WATTS	14" LEADS	PRICE	26" LEADS	PRICE	38" LEADS	PRICE
16	240	2500	HT62160C-14S	\$105.88	HT62160C-26S	\$111.52	HT62160C-38S	\$117.16
16	240	4500	HT62160D-14S	\$105.88	HT62160D-26S	\$111.52	HT62160D-38S	\$117.16
18	120	750	HT62180A-14S	\$116.28	HT62180A-26S	\$121.92	HT62180A-38S	\$127.56
18	240	1000	HT62180B-14S	\$116.28	HT62180B-26S	\$121.92	HT62180B-38S	\$127.56
18	240	1500	HT62180C-14S	\$116.28	HT62180C-26S	\$121.92	HT62180C-38S	\$127.56
18	240	3000	HT62180A-14S	\$116.28	HT62180A-26S	\$121.92	HT62180A-38S	\$127.56
20	120	875	HT62200A-14S	\$126.68	HT62200A-26S	\$132.32	HT62200A-38S	\$137.96
20	240	1500	HT62200B-14S	\$126.68	HT62200B-26S	\$132.32	HT62200B-38S	\$137.96
20	240	3500	HT62200A-14S	\$126.68	HT62200A-26S	\$132.32	HT62200A-38S	\$137.96
24	120	500	HT62240C-14S	\$147.48	HT62240C-26S	\$153.12	HT62240C-38S	\$158.76
24	240	500	HT62240D-14S	\$147.48	HT62240D-26S	\$153.12	HT62240D-38S	\$158.76
24	240	1000	HT62240A-14S	\$147.48	HT62240A-26S	\$153.12	HT62240A-38S	\$158.76
24	240	1500	HT62240B-14S	\$147.48	HT62240B-26S	\$153.12	HT62240B-38S	\$158.76
24	240	2000	HT62240C-14S	\$147.48	HT62240C-26S	\$153.12	HT62240C-38S	\$158.76
24	480	2000	HT62240D-14S	\$147.48	HT62240D-26S	\$153.12	HT62240D-38S	\$158.76
30	240	1500	HT62300A-14S	\$178.68	HT62300A-26S	\$184.32	HT62300A-38S	\$189.96
30	480	1500	HT62300B-14S	\$178.68	HT62300B-26S	\$184.32	HT62300B-38S	\$189.96
32	240	2000	HT62320A-14S	\$189.08	HT62320A-26S	\$194.72	HT62320A-38S	\$200.36

Do not see what you need?

We can build to your specifications!

.625" Diameter Options Selection

Lead Options



Price	No Additional Charge
-------	----------------------

Solid Nickel Pins

Utilized in high heat applications and where there is no movement or vibration. Lead wires can be added via exterior crimps. Damaged wires can be replaced quickly.



Price	First 14"	Per additional 12"
	No Charge	\$2.79

Fiberglass Leads (Standard)

Pure nickel conductors insulated with 950°F fiberglass insulation.



Price	First 14"	Per Additional 12"
	\$3.73	\$1.89

Silicon Leads

Ideal for high movement applications where there is limited heat. Can withstand temperatures up to 450°F. Provides limited protection to moisture. Requires Silicon Potting to be utilized.



Price	First 14"	Per Additional 12"
	\$3.73	\$1.89

Teflon Leads

Ideal for excessive movement and high vibration applications. Can withstand moderate temperatures 450°F. Provides limited protection from moisture. Requires either silicon potting or a Teflon seal.

.625" Diameter Options Selection

Lead Protection Options



Price	First 12"	Per Additional 12"
	\$3.99	\$1.78

Fiberglass Sleeving

Protection against high temperatures up to 950°F while providing moderate protection against friction.



Price	First 12"	Per Additional 12"
	\$9.89	\$4.15

Braided Metal Sleeving (BMS)

Ideal for high friction and constant bending. Stainless steel construction with high flexibility.



Price	First 12"	Per Additional 12"
	\$13.25	\$5.55

Armor Conduit

Water resistant interlocking design allows for limited exposure to moisture. Flexibility allows an added level of protection against physical damage to the lead wires.

All options can be added to stock items and shipped within 24 hours of ordering!

.625" Diameter Options Selection Page

NPT Fittings

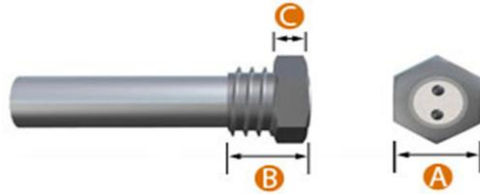

Specifications	3/8" Diameter
A	.785"
B	1.00"
C	.250"
NPT Fitting	1/2

	Stainless Steel	Brass
Price	\$19.89	\$17.97

Right Angle Block Exit with Knockout Tab



Specifications	
A	.710"
B	.196"
C	.475"

	Right Angle Block	Knockout Tab
Price	\$26.20	\$8.73

All options can be added to stock items and shipped within 24 hours of ordering!

.625" Diameter Options Selection Page

Optional Exit Styles

Right Angle Exit

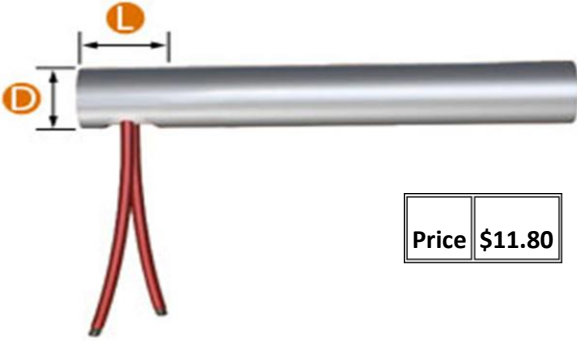

Price \$11.80

Specifications	
D	.625"
L	.625"

Right Angle Exit with Stress Relief Tube

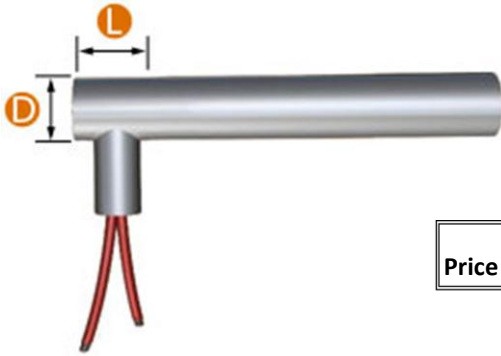

Price \$11.80

Specifications	
D	.625"
L	.625"

Right Angle Elbow

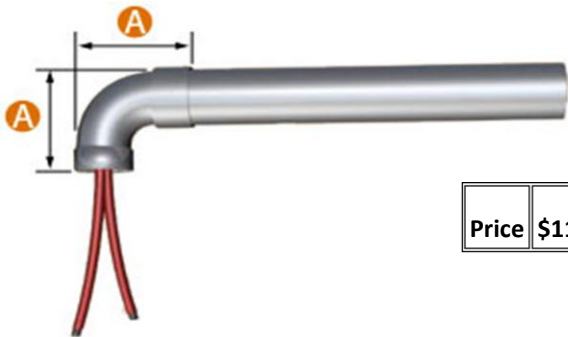

Price \$11.80

Specifications	
A	.75"

All options can be added to stock items and shipped within 24 hours of ordering!

Stock .75" Diameter Heaters

LENGTH	OAL	VOLTS	WATTS	14" LEADS	PRICE	26" LEADS	PRICE	38" LEADS
2	240	250	HT75020A-14S	\$37.48	HT75020A-26S	\$43.12	HT75020A-38S	\$48.76
3	240	225	HT75030A-14S	\$44.03	HT75030A-26S	\$49.67	HT75030A-38S	\$55.31
3	240	400	HT75030B-14S	\$44.03	HT75030B-26S	\$49.67	HT75030B-38S	\$55.31
3	120	500	HT75030C-14S	\$44.03	HT75030C-26S	\$49.67	HT75030C-38S	\$55.31
3	240	500	HT75030D-14S	\$44.03	HT75030D-26S	\$49.67	HT75030D-38S	\$55.31
4	120	250	HT75040B-14S	\$51.58	HT75040B-26S	\$57.22	HT75040B-38S	\$62.86
4	240	750	HT75040A-14S	\$51.58	HT75040A-26S	\$57.22	HT75040A-38S	\$62.86
4	240	1000	HT75040B-14S	\$51.58	HT75040B-26S	\$57.22	HT75040B-38S	\$62.86
5	120	250	HT75050B-14S	\$57.08	HT75050B-26S	\$62.72	HT75050B-38S	\$68.36
5	240	500	HT75050A-14S	\$57.08	HT75050A-26S	\$62.72	HT75050A-38S	\$68.36
5	240	1000	HT75050B-14S	\$57.08	HT75050B-26S	\$62.72	HT75050B-38S	\$68.36
6	120	375	HT75060E-14S	\$63.63	HT75060E-26S	\$69.27	HT75060E-38S	\$74.91
6	120	500	HT75060A-14S	\$63.63	HT75060A-26S	\$69.27	HT75060A-38S	\$74.91
6	240	500	HT75060B-14S	\$63.63	HT75060B-26S	\$69.27	HT75060B-38S	\$74.91
6	240	1000	HT75060C-14S	\$63.63	HT75060C-26S	\$69.27	HT75060C-38S	\$74.91
6	240	1200	HT75060D-14S	\$63.63	HT75060D-26S	\$69.27	HT75060D-38S	\$74.91
6	240	1500	HT75060E-14S	\$63.63	HT75060E-26S	\$69.27	HT75060E-38S	\$74.91
6	240	2000	HT75060A-14S	\$63.63	HT75060A-26S	\$69.27	HT75060A-38S	\$74.91
7	120	375	HT75070C-14S	\$70.18	HT75070C-26S	\$75.82	HT75070C-38S	\$81.46
7	240	500	HT75070A-14S	\$70.18	HT75070A-26S	\$75.82	HT75070A-38S	\$81.46
7	240	1000	HT75070B-14S	\$70.18	HT75070B-26S	\$75.82	HT75070B-38S	\$81.46
7	240	1500	HT75070C-14S	\$70.18	HT75070C-26S	\$75.82	HT75070C-38S	\$81.46
8	120	350	HT75080C-14S	\$76.73	HT75080C-26S	\$82.37	HT75080C-38S	\$88.01
8	240	350	HT75080E-14S	\$76.73	HT75080E-26S	\$82.37	HT75080E-38S	\$88.01
8	120	500	HT75080D-14S	\$76.73	HT75080D-26S	\$82.37	HT75080D-38S	\$88.01
8	240	600	HT75080A-14S	\$76.73	HT75080A-26S	\$82.37	HT75080A-38S	\$88.01
8	240	750	HT75080F-14S	\$76.73	HT75080F-26S	\$82.37	HT75080F-38S	\$88.01
8	240	1000	HT75080B-14S	\$76.73	HT75080B-26S	\$82.37	HT75080B-38S	\$88.01
8	240	1500	HT75080C-14S	\$76.73	HT75080C-26S	\$82.37	HT75080C-38S	\$88.01
8	480	1500	HT75080E-14S	\$76.73	HT75080E-26S	\$82.37	HT75080E-38S	\$88.01
8	240	2000	HT75080D-14S	\$76.73	HT75080D-26S	\$82.37	HT75080D-38S	\$88.01

Stock .75" Diameter Heaters (Continued)

LENGTH	OAL	VOLTS	WATTS	14" LEADS	PRICE	26" LEADS	PRICE	38" LEADS
9	120	350	HT75090D-14S	\$83.23	HT75090D-26S	\$88.87	HT75090D-38S	\$94.51
9	240	350	HT75090B-14S	\$83.23	HT75090B-26S	\$88.87	HT75090B-38S	\$94.51
9	240	1000	HT75090C-14S	\$83.23	HT75090C-26S	\$88.87	HT75090C-38S	\$94.51
9	240	1400	HT75090D-14S	\$83.23	HT75090D-26S	\$88.87	HT75090D-38S	\$94.51
9	480	1400	HT75090B-14S	\$83.23	HT75090B-26S	\$88.87	HT75090B-38S	\$94.51
9	240	1800	HT75090A-14S	\$83.23	HT75090A-26S	\$88.87	HT75090A-38S	\$94.51
10	120	500	HT75100C-14S	\$89.78	HT75100C-26S	\$95.42	HT75100C-38S	\$101.06
10	120	750	HT75100F-14S	\$89.78	HT75100F-26S	\$95.42	HT75100F-38S	\$101.06
10	240	1000	HT75100A-14S	\$89.78	HT75100A-26S	\$95.42	HT75100A-38S	\$101.06
10	240	1200	HT75100E-14S	\$89.78	HT75100E-26S	\$95.42	HT75100E-38S	\$101.06
10	240	1500	HT75100B-14S	\$89.78	HT75100B-26S	\$95.42	HT75100B-38S	\$101.06
10	240	2000	HT75100C-14S	\$89.78	HT75100C-26S	\$95.42	HT75100C-38S	\$101.06
10	240	3000	HT75100F-14S	\$89.78	HT75100F-26S	\$95.42	HT75100F-38S	\$101.06
12	120	500	HT75120D-14S	\$102.88	HT75120D-26S	\$108.52	HT75120D-38S	\$114.16
12	240	500	HT75120E-14S	\$102.88	HT75120E-26S	\$108.52	HT75120E-38S	\$114.16
12	120	1000	HT75120A-14S	\$102.88	HT75120A-26S	\$108.52	HT75120A-38S	\$114.16
12	240	1000	HT75120B-14S	\$102.88	HT75120B-26S	\$108.52	HT75120B-38S	\$114.16
12	240	1500	HT75120C-14S	\$102.88	HT75120C-26S	\$108.52	HT75120C-38S	\$114.16
12	240	2000	HT75120D-14S	\$102.88	HT75120D-26S	\$108.52	HT75120D-38S	\$114.16
12	480	2000	HT75120E-14S	\$102.88	HT75120E-26S	\$108.52	HT75120E-38S	\$114.16
12	240	2500	HT75120F-14S	\$102.88	HT75120F-26S	\$108.52	HT75120F-38S	\$114.16
14	240	2000	HT75140A-14S	\$115.98	HT75140A-26S	\$121.62	HT75140A-38S	\$127.26
14	240	4500	HT75140B-14S	\$115.98	HT75140B-26S	\$121.62	HT75140B-38S	\$127.26
15	240	1000	HT75150A-14S	\$122.48	HT75150A-26S	\$128.12	HT75150A-38S	\$133.76
16	240	875	HT75160B-14S	\$129.03	HT75160B-26S	\$134.67	HT75160B-38S	\$140.31
16	240	1000	HT75160C-14S	\$129.03	HT75160C-26S	\$134.67	HT75160C-38S	\$140.31
16	240	1600	HT75160A-14S	\$129.03	HT75160A-26S	\$134.67	HT75160A-38S	\$140.31
16	480	3500	HT75160B-14S	\$129.03	HT75160B-26S	\$134.67	HT75160B-38S	\$140.31
12	240	2000	HT75120D-14S	\$102.88	HT75120D-26S	\$108.52	HT75120D-38S	\$114.16
12	480	2000	HT75120E-14S	\$102.88	HT75120E-26S	\$108.52	HT75120E-38S	\$114.16
12	240	2500	HT75120F-14S	\$102.88	HT75120F-26S	\$108.52	HT75120F-38S	\$114.16
14	240	2000	HT75140A-14S	\$115.98	HT75140A-26S	\$121.62	HT75140A-38S	\$127.26
14	240	4500	HT75140B-14S	\$115.98	HT75140B-26S	\$121.62	HT75140B-38S	\$127.26

Stock .75" Diameter Heaters (Continued)

LENGTH	OAL	VOLTS	WATTS	14" LEADS	PRICE	26" LEADS	PRICE	38" LEADS
15	240	1000	HT75150A-14S	\$122.48	HT75150A-26S	\$128.12	HT75150A-38S	\$133.76
16	240	875	HT75160B-14S	\$129.03	HT75160B-26S	\$134.67	HT75160B-38S	\$140.31
16	240	1000	HT75160C-14S	\$129.03	HT75160C-26S	\$134.67	HT75160C-38S	\$140.31
16	240	1600	HT75160A-14S	\$129.03	HT75160A-26S	\$134.67	HT75160A-38S	\$140.31
16	480	3500	HT75160B-14S	\$129.03	HT75160B-26S	\$134.67	HT75160B-38S	\$140.31
18	240	1000	HT75180A-14S	\$142.13	HT75180A-26S	\$147.77	HT75180A-38S	\$153.41
18	240	2000	HT75180B-14S	\$142.13	HT75180B-26S	\$147.77	HT75180B-38S	\$153.41
18	480	2000	HT75180C-14S	\$142.13	HT75180C-26S	\$147.77	HT75180C-38S	\$153.41
18	240	2400	HT75180D-14S	\$142.13	HT75180D-26S	\$147.77	HT75180D-38S	\$153.41
20	240	1200	HT75200A-14S	\$155.18	HT75200A-26S	\$160.82	HT75200A-38S	\$166.46
20	240	2250	HT75200B-14S	\$155.18	HT75200B-26S	\$160.82	HT75200B-38S	\$166.46
24	240	1000	HT75240A-14S	\$181.38	HT75240A-26S	\$187.02	HT75240A-38S	\$192.66
24	240	1500	HT75240B-14S	\$181.38	HT75240B-26S	\$187.02	HT75240B-38S	\$192.66
24	240	2000	HT75240C-14S	\$181.38	HT75240C-26S	\$187.02	HT75240C-38S	\$192.66
24	480	2500	HT75240D-14S	\$181.38	HT75240D-26S	\$187.02	HT75240D-38S	\$192.66
24	240	3000	HT75240E-14S	\$181.38	HT75240E-26S	\$187.02	HT75240E-38S	\$192.66
24	480	4000	HT75240A-14S	\$181.38	HT75080C-26S	\$187.02	HT75080C-38S	\$192.66
28	240	2400	HT75280A-14S	\$207.58	HT75280A-26S	\$213.22	HT75280A-38S	\$218.86
30	240	2000	HT75300A-14S	\$220.68	HT75300A-26S	\$226.32	HT75300A-38S	\$231.96
32	240	2000	HT75320A-14S	\$233.78	HT75320A-26S	\$239.42	HT75320A-38S	\$245.06
36	240	2000	HT75360A-14S	\$259.98	HT75360A-26S	\$265.62	HT75360A-38S	\$271.26

Do not see what you need?

We can build to your specifications!

.75" Diameter Options Selection

Lead Options



Price	No Additional Charge
-------	----------------------

Solid Nickel Pins
Utilized in high heat applications and where there is no movement or vibration. Lead wires can be added via exterior crimps. Damaged wires can be replaced quickly.



Price	First 14"	Per Additional 12"
	No Charge	\$2.79

Fiberglass Leads (Standard)
Pure nickel conductors insulated with 950°F fiberglass insulation.



Price	First 14"	Per Additional 12"
	\$3.73	\$1.89

Silicon Leads
Ideal for high movement applications where there is limited heat. Can withstand temperatures up to 450°F. Provides limited protection to moisture. Requires Silicon Potting to be utilized.



Price	First 14"	Per Additional 12"
	\$3.73	\$1.89

Teflon Leads
Ideal for excessive movement and high vibration applications. Can withstand moderate temperatures 450°F. Provides limited protection from moisture. Requires either silicon potting or a Teflon seal.

.75" Diameter Options Selection Page

Lead Protection Options



Price	First 12"	Per Additional 12"
	\$3.99	\$1.78

Fiberglass Sleeving

Protection against high temperatures up to 950°F while providing moderate protection against friction.



Price	First 12"	Per Additional 12"
	\$9.89	\$4.15

Braided Metal Sleeving (BMS)

Ideal for high friction and constant bending. Stainless steel construction with high flexibility.



Price	First 12"	Per Additional 12"
	\$13.25	\$5.55

Armor Conduit

Water resistant interlocking design allows for limited exposure to moisture. Flexibility allows an added level of protection against physical damage to the lead wires.

All options can be added to stock items and shipped within 24 hours of ordering!

.75" Diameter Options Selection

NPT Fittings

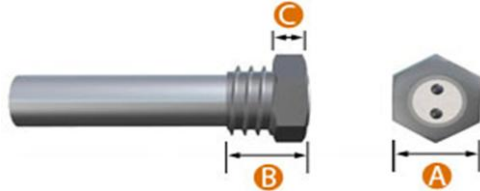

	Stainless Steel	Brass
Price	\$27.89	\$25.97

Specifications	.75" Diameter
A	.100"
B	1.18"
C	.275"
NPT Fitting	3/4

Right Angle Block Exit with Knockout Tab

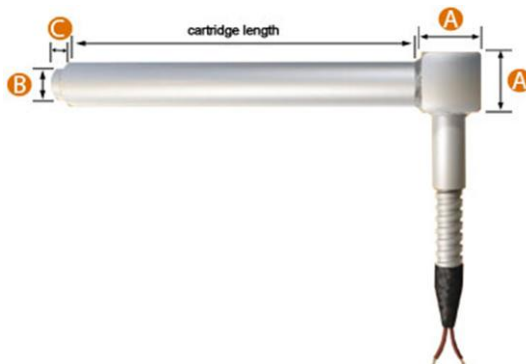

Specifications	
A	.866"
B	.590"
C	.196"

	Right Angle Block	Knockout Tab
Price	\$30.20	\$12.73

All options can be added to stock items and shipped within 24 hours of ordering!

.75" Diameter Options Selection Page

Optional Exit Styles

Right Angle Exit

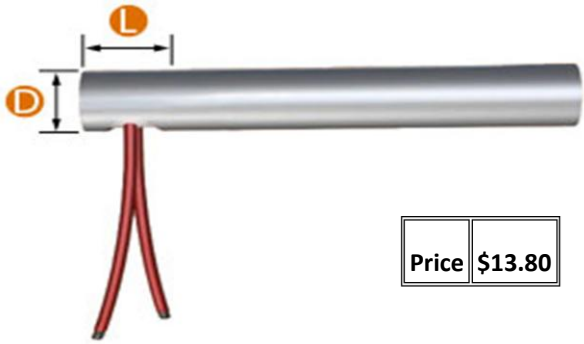

Price \$13.80

Specifications	
D	.75"
L	.625"

Right Angle Exit with Stress Relief Tube

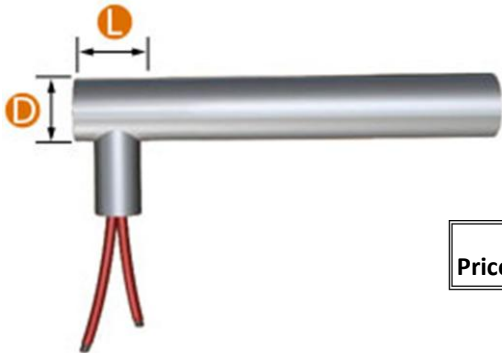

Price \$16.80

Specifications	
D	.75"
L	.625"

Right Angle Elbow

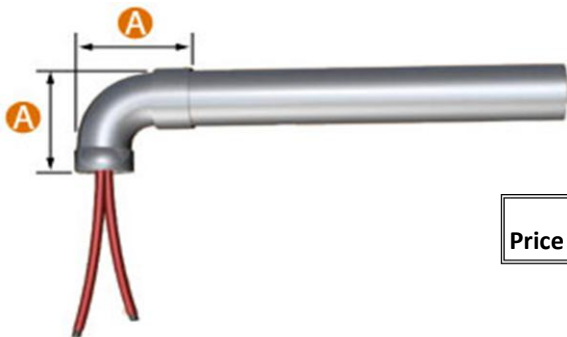

Price \$13.80

Specifications	
A	.75"

All options can be added to stock items and shipped within 24 hours of ordering!

Stock 1" Diameter Heaters

LENGTH	OAL	VOLTS	WATTS	14" LEADS	PRICE	26" LEADS	PRICE	38" LEADS
2	240	250	HT10020A-14S	\$41.23	HT10020A-26S	\$47.43	HT10020A-38S	\$53.64
3	240	225	HT10030A-14S	\$48.43	HT10030A-26S	\$54.64	HT10030A-38S	\$60.84
3	240	400	HT10030B-14S	\$48.43	HT10030B-26S	\$54.64	HT10030B-38S	\$60.84
3	120	500	HT10030C-14S	\$48.43	HT10030C-26S	\$54.64	HT10030C-38S	\$60.84
3	240	500	HT10030D-14S	\$48.43	HT10030D-26S	\$54.64	HT10030D-38S	\$60.84
4	120	250	HT10040B-14S	\$56.74	HT10040B-26S	\$62.94	HT10040B-38S	\$69.15
4	240	750	HT10040A-14S	\$56.74	HT10040A-26S	\$62.94	HT10040A-38S	\$69.15
4	240	1000	HT10040B-14S	\$56.74	HT10040B-26S	\$62.94	HT10040B-38S	\$69.15
5	120	250	HT10050B-14S	\$62.79	HT10050B-26S	\$68.99	HT10050B-38S	\$75.20
5	240	500	HT10050A-14S	\$62.79	HT10050A-26S	\$68.99	HT10050A-38S	\$75.20
5	240	1000	HT10050B-14S	\$62.79	HT10050B-26S	\$68.99	HT10050B-38S	\$75.20
6	120	375	HT10060E-14S	\$69.99	HT10060E-26S	\$76.20	HT10060E-38S	\$82.40
6	120	500	HT10060A-14S	\$69.99	HT10060A-26S	\$76.20	HT10060A-38S	\$82.40
6	240	500	HT10060B-14S	\$69.99	HT10060B-26S	\$76.20	HT10060B-38S	\$82.40
6	240	1000	HT10060C-14S	\$69.99	HT10060C-26S	\$76.20	HT10060C-38S	\$82.40
6	240	1200	HT10060D-14S	\$69.99	HT10060D-26S	\$76.20	HT10060D-38S	\$82.40
6	240	1500	HT10060E-14S	\$69.99	HT10060E-26S	\$76.20	HT10060E-38S	\$82.40
6	240	2000	HT10060A-14S	\$69.99	HT10060A-26S	\$76.20	HT10060A-38S	\$82.40
7	120	375	HT10070C-14S	\$77.20	HT10070C-26S	\$83.40	HT10070C-38S	\$89.61
7	240	500	HT10070A-14S	\$77.20	HT10070A-26S	\$83.40	HT10070A-38S	\$89.61
7	240	1000	HT10070B-14S	\$77.20	HT10070B-26S	\$83.40	HT10070B-38S	\$89.61
7	240	1500	HT10070C-14S	\$77.20	HT10070C-26S	\$83.40	HT10070C-38S	\$89.61
8	120	350	HT10080C-14S	\$84.40	HT10080C-26S	\$90.61	HT10080C-38S	\$96.81
8	240	350	HT10080E-14S	\$84.40	HT10080E-26S	\$90.61	HT10080E-38S	\$96.81
8	120	500	HT10080D-14S	\$84.40	HT10080D-26S	\$90.61	HT10080D-38S	\$96.81
8	240	600	HT10080A-14S	\$84.40	HT10080A-26S	\$90.61	HT10080A-38S	\$96.81
8	240	750	HT10080F-14S	\$84.40	HT10080F-26S	\$90.61	HT10080F-38S	\$96.81
8	240	1000	HT10080B-14S	\$84.40	HT10080B-26S	\$90.61	HT10080B-38S	\$96.81
8	240	1500	HT10080C-14S	\$84.40	HT10080C-26S	\$90.61	HT10080C-38S	\$96.81
8	480	1500	HT10080E-14S	\$84.40	HT10080E-26S	\$90.61	HT10080E-38S	\$96.81
8	240	2000	HT10080D-14S	\$84.40	HT10080D-26S	\$90.61	HT10080D-38S	\$96.81

Stock 1" Diameter Heaters (Continued)

LENGTH	OAL	VOLTS	WATTS	14" LEADS	PRICE	26" LEADS	PRICE	38" LEADS
9	120	350	HT10090D-14S	\$91.55	HT10090D-26S	\$97.76	HT10090D-38S	\$103.96
9	240	350	HT10090B-14S	\$91.55	HT10090B-26S	\$97.76	HT10090B-38S	\$103.96
9	240	1000	HT10090C-14S	\$91.55	HT10090C-26S	\$97.76	HT10090C-38S	\$103.96
9	240	1400	HT10090D-14S	\$91.55	HT10090D-26S	\$97.76	HT10090D-38S	\$103.96
9	480	1400	HT10090B-14S	\$91.55	HT10090B-26S	\$97.76	HT10090B-38S	\$103.96
9	240	1800	HT10090A-14S	\$91.55	HT10090A-26S	\$97.76	HT10090A-38S	\$103.96
10	120	500	HT10100C-14S	\$98.76	HT10100C-26S	\$104.96	HT10100C-38S	\$111.17
10	120	750	HT10100F-14S	\$98.76	HT10100F-26S	\$104.96	HT10100F-38S	\$111.17
10	240	1000	HT10100A-14S	\$98.76	HT10100A-26S	\$104.96	HT10100A-38S	\$111.17
10	240	1200	HT10100E-14S	\$98.76	HT10100E-26S	\$104.96	HT10100E-38S	\$111.17
10	240	1500	HT10100B-14S	\$98.76	HT10100B-26S	\$104.96	HT10100B-38S	\$111.17
10	240	2000	HT10100C-14S	\$98.76	HT10100C-26S	\$104.96	HT10100C-38S	\$111.17
10	240	3000	HT10100F-14S	\$98.76	HT10100F-26S	\$104.96	HT10100F-38S	\$111.17
12	120	500	HT10120D-14S	\$113.17	HT10120D-26S	\$119.37	HT10120D-38S	\$125.58
12	240	500	HT10120E-14S	\$113.17	HT10120E-26S	\$119.37	HT10120E-38S	\$125.58
12	120	1000	HT10120A-14S	\$113.17	HT10120A-26S	\$119.37	HT10120A-38S	\$125.58
12	240	1000	HT10120B-14S	\$113.17	HT10120B-26S	\$119.37	HT10120B-38S	\$125.58
12	240	1500	HT10120C-14S	\$113.17	HT10120C-26S	\$119.37	HT10120C-38S	\$125.58
12	240	2000	HT10120D-14S	\$113.17	HT10120D-26S	\$119.37	HT10120D-38S	\$125.58
12	480	2000	HT10120E-14S	\$113.17	HT10120E-26S	\$119.37	HT10120E-38S	\$125.58
12	240	2500	HT10120F-14S	\$113.17	HT10120F-26S	\$119.37	HT10120F-38S	\$125.58
14	240	2000	HT10140A-14S	\$127.58	HT10140A-26S	\$133.78	HT10140A-38S	\$139.99
14	240	4500	HT10140B-14S	\$127.58	HT10140B-26S	\$133.78	HT10140B-38S	\$139.99
15	240	1000	HT10150A-14S	\$134.73	HT10150A-26S	\$140.93	HT10150A-38S	\$147.14
16	240	875	HT10160B-14S	\$141.93	HT10160B-26S	\$148.14	HT10160B-38S	\$154.34
16	240	1000	HT10160C-14S	\$141.93	HT10160C-26S	\$148.14	HT10160C-38S	\$154.34
16	240	1600	HT10160A-14S	\$141.93	HT10160A-26S	\$148.14	HT10160A-38S	\$154.34
16	480	3500	HT10160B-14S	\$141.93	HT10160B-26S	\$148.14	HT10160B-38S	\$154.34
12	240	2000	HT10120D-14S	\$113.17	HT10120D-26S	\$119.37	HT10120D-38S	\$125.58
12	480	2000	HT10120E-14S	\$113.17	HT10120E-26S	\$119.37	HT10120E-38S	\$125.58
12	240	2500	HT10120F-14S	\$113.17	HT10120F-26S	\$119.37	HT10120F-38S	\$125.58
14	240	2000	HT10140A-14S	\$127.58	HT10140A-26S	\$133.78	HT10140A-38S	\$139.99
14	240	4500	HT10140B-14S	\$127.58	HT10140B-26S	\$133.78	HT10140B-38S	\$139.99

Stock 1" Diameter Heaters (Continued)

LENGTH	OAL	VOLTS	WATTS	14" LEADS	PRICE	26" LEADS	PRICE	38" LEADS
15	240	1000	HT10150A-14S	\$134.73	HT10150A-26S	\$140.93	HT10150A-38S	\$147.14
16	240	875	HT10160B-14S	\$141.93	HT10160B-26S	\$148.14	HT10160B-38S	\$154.34
16	240	1000	HT10160C-14S	\$141.93	HT10160C-26S	\$148.14	HT10160C-38S	\$154.34
16	240	1600	HT10160A-14S	\$141.93	HT10160A-26S	\$148.14	HT10160A-38S	\$154.34
16	480	3500	HT10160B-14S	\$141.93	HT10160B-26S	\$148.14	HT10160B-38S	\$154.34
18	240	1000	HT10180A-14S	\$156.34	HT10180A-26S	\$162.55	HT10180A-38S	\$168.75
18	240	2000	HT10180B-14S	\$156.34	HT10180B-26S	\$162.55	HT10180B-38S	\$168.75
18	480	2000	HT10180C-14S	\$156.34	HT10180C-26S	\$162.55	HT10180C-38S	\$168.75
18	240	2400	HT10180D-14S	\$156.34	HT10180D-26S	\$162.55	HT10180D-38S	\$168.75
20	240	1200	HT10200A-14S	\$170.70	HT10200A-26S	\$176.90	HT10200A-38S	\$183.11
20	240	2250	HT10200B-14S	\$170.70	HT10200B-26S	\$176.90	HT10200B-38S	\$183.11
24	240	1000	HT10240A-14S	\$199.52	HT10240A-26S	\$205.72	HT10240A-38S	\$211.93
24	240	1500	HT10240B-14S	\$199.52	HT10240B-26S	\$205.72	HT10240B-38S	\$211.93
24	240	2000	HT10240C-14S	\$199.52	HT10240C-26S	\$205.72	HT10240C-38S	\$211.93
24	480	2500	HT10240D-14S	\$199.52	HT10240D-26S	\$205.72	HT10240D-38S	\$211.93
24	240	3000	HT10240E-14S	\$199.52	HT10240E-26S	\$205.72	HT10240E-38S	\$211.93
24	480	4000	HT10240A-14S	\$199.52	HT10080C-26S	\$205.72	HT10080C-38S	\$211.93
28	240	2400	HT10280A-14S	\$228.34	HT10280A-26S	\$234.54	HT10280A-38S	\$240.75
30	240	2000	HT10300A-14S	\$242.75	HT10300A-26S	\$248.95	HT10300A-38S	\$255.16
32	240	2000	HT10320A-14S	\$257.16	HT10320A-26S	\$263.36	HT10320A-38S	\$269.57
36	240	2000	HT10360A-14S	\$285.98	HT10360A-26S	\$292.18	HT10360A-38S	\$298.39

Do not see what you need?

We can build to your specifications!

1" Diameter Options Selection

Lead Options



Price	No Additional Charge
-------	----------------------

Solid Nickel Pins
Utilized in high heat applications and where there is no movement or vibration. Lead wires can be added via exterior crimps. Damaged wires can be replaced quickly.



Price	First 14"	Per Additional 12"
	No Charge	\$2.79

Fiberglass Leads (Standard)
Pure nickel conductors insulated with 950°F fiberglass insulation.



Price	First 14"	Per Additional 12"
	\$3.73	\$1.89

Silicon Leads
Ideal for high movement applications where there is limited heat. Can withstand temperatures up to 450°F. Provides limited protection to moisture. Requires Silicon Potting to be utilized.



Price	First 14"	Per Additional 12"
	\$3.73	\$1.89

Teflon Leads
Ideal for excessive movement and high vibration applications. Can withstand moderate temperatures 450°F. Provides limited protection from moisture. Requires either silicon potting or a Teflon seal.

1" Diameter Options Selection Page

Lead Protection Options



Price	First 12"	Per Additional 12"
	\$3.99	\$1.78

Fiberglass Sleeving

Protection against high temperatures up to 950°F while providing moderate protection against friction.



Price	First 12"	Per Additional 12"
	\$9.89	\$4.15

Braided Metal Sleeving (BMS)

Ideal for high friction and constant bending. Stainless steel construction with high flexibility.



Price	First 12"	Per Additional 12"
	\$13.25	\$5.55

Armor Conduit

Water resistant interlocking design allows for limited exposure to moisture. Flexibility allows an added level of protection against physical damage to the lead wires.

All options can be added to stock items and shipped within 24 hours of ordering!

1" Diameter Options Selection

NPT Fittings

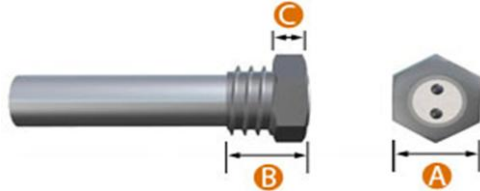

	Stainless Steel	Brass
Price	\$27.89	\$25.97

Specifications	.75" Diameter
A	.100"
B	1.18"
C	.275"
NPT Fitting	3/4

Right Angle Block Exit with Knockout Tab

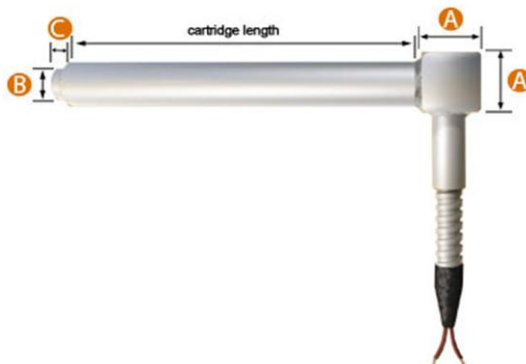

Specifications	
A	.866"
B	.590"
C	.196"

	Right Angle Block	Knockout Tab
Price	\$30.20	\$12.73

All options can be added to stock items and shipped within 24 hours of ordering!

1" Diameter Options Selection Page

Optional Exit Styles

Right Angle Exit

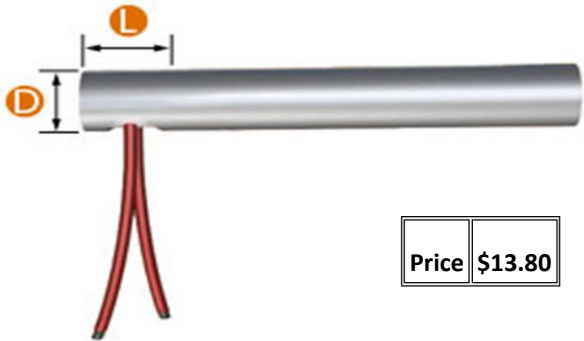

Price \$13.80

Specifications	
D	.75"
L	.625"

Right Angle Exit with Stress Relief Tube

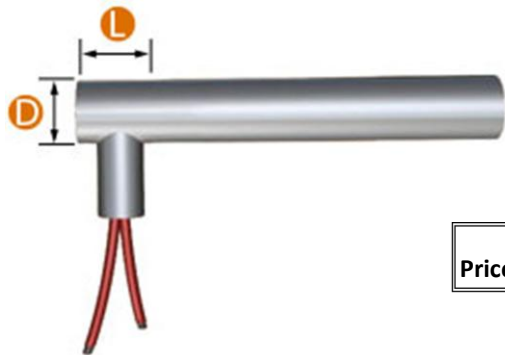

Price \$16.80

Specifications	
D	.75"
L	.625"

Right Angle Elbow

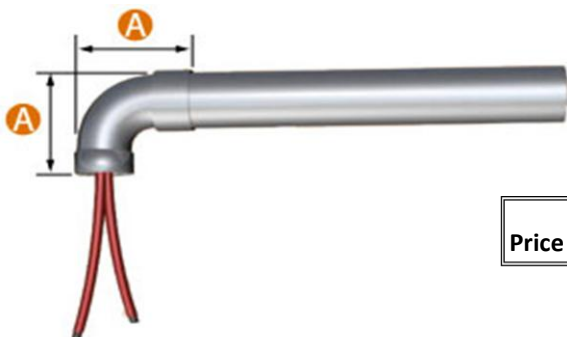

Price \$13.80

Specifications	
A	.75"

All options can be added to stock items and shipped within 24 hours of ordering!

DME Equivalent Low Watt Density Heaters 10" Swaged with High Temperature Leads

DIA	LENGTH	WATTS	VOLTS	DME PART	WATLOW PART	HTI PART	PRICE
1/4	2	40	120	CU-202-1		HT25020AX	\$21.10
1/4	2	40	240	CU-202-2		HT25020AY	\$21.10
1/4	3	75	120	CU-203-1		HT25030AR	\$24.25
1/4	3	75	240	CU-203-2		HT25030AS	\$24.25
1/4	4	100	120	CU-204-1	E4A28	HT25040J	\$27.40
1/4	4	100	240	CU-204-2		HT25040AQ	\$27.40
1/4	6	150	120	CU-206-1		HT25060AC	\$33.70
1/4	6	150	240	CU-206-2		HT25060AD	\$33.70
3/8	2	75	120	CU-302-1		HT37020BF	\$21.60
3/8	2	75	240	CU-302-2		HT37020BG	\$21.60
3/8	3	100	120	CU-303-1		HT37030U	\$25.15
3/8	3	100	240	CU-303-2	G3A137	HT37030V	\$25.15
3/8	4	150	120	CU-304-1	G4A78	HT37040Y	\$28.70
3/8	5	185	120	CU-305-1		HT37050BN	\$32.25
3/8	5	185	240	CU-305-2		HT37050BP	\$32.25
3/8	6	225	120	CU-306-1		HT37060BL	\$35.80
3/8	6	225	240	CU-306-2		HT37060BM	\$35.80
3/8	8	300	120	CU-308-1	G8A54	HT37080AP	\$42.90
3/8	8	300	240	CU-308-2	G8A47	HT37080Y	\$42.90
1/2	2	75	120	CU-402-1	JA280	HT50020Z	\$24.50
1/2	2	75	240	CU-402-2		HT50020AA	\$24.50
1/2	3	150	120	CU-403-1		HT50030AP	\$29.20
1/2	3	150	240	CU-403-2		HT50030AQ	\$29.20
1/2	4	180	120	CU-404-1		HT50040AX	\$33.90
1/2	4	180	240	CU-404-2		HT50040AY	\$33.90
1/2	5	200	120	CU-405-1	J5A85	HT50050M	\$38.60
1/2	5	200	240	CU-405-2	J5A74	HT50050N	\$38.60
1/2	6	300	120	CU-406-1		HT50060V	\$43.25
1/2	6	300	240	CU-406-2	J6A66	HT50060W	\$43.25
1/2	8	400	120	CU-408-1		HT50080BN	\$52.65
1/2	8	400	240	CU-408-2		HT50080BP	\$52.65
1/2	10	500	120	CU-410-1		HT50100K	\$62.00
1/2	10	500	240	CU-410-2	J10A62	HT50100M	\$62.00
1/2	12	600	120	CU-412-1		HT50120AF	\$71.40
1/2	12	600	240	CU-412-2		HT50120AG	\$71.40
1/2	16	800	120	CU-416-1		HT50160T	\$90.15

DME Equivalent Low Watt Density Heaters 10" Swaged with High Temperature Leads (Continued)

DIA	LENGTH	WATTS	VOLTS	DME PART	WATLOW PART	HTI PART	PRICE
1/2	16	800	240	CU-416-2		HT50160U	\$90.15
5/8	2	100	120	CU-502-1	L2A48	HT62020F	\$25.95
5/8	2	100	240	CU-502-2		HT62020G	\$25.95
5/8	3	200	120	CU-503-1		HT62030R	\$31.15
5/8	3	200	240	CU-503-2		HT62030S	\$31.15
5/8	4	250	120	CU-504-1	L4A99	HT62040AH	\$36.35
5/8	4	250	240	CU-504-2		HT62040AJ	\$36.35
5/8	5	300	120	CU-505-1		HT62050V	\$41.55
5/8	5	300	240	CU-505-2		HT62050W	\$41.55
5/8	6	375	120	CU-506-1		HT62060W	\$46.75
5/8	6	375	240	CU-506-2		HT62060X	\$46.75
5/8	8	500	120	CU-508-1	L8A96	HT62080AB	\$57.15
5/8	8	500	240	CU-508-2	L8A46	HT62080AC	\$57.15
5/8	10	650	120	CU-510-1		HT62100S	\$67.55
5/8	10	650	240	CU-510-2		HT62100T	\$67.55
5/8	12	775	240	CU-512-1		HT62120R	\$77.95
5/8	12	775	120	CU-512-1		HT62120Q	\$77.95
5/8	14	900	240	CU-514-2		HT62140M	\$88.35
5/8	16	1050	120	CU-516-1		HT62160V	\$98.80
5/8	16	1050	240	CU-516-2		HT62160W	\$98.80
3/4	2	200	240	CU-602-2		HT75020B	\$29.05
3/4	3	225	240	CU-603-2		HT75030H	\$35.60
3/4	4	300	120	CU-604-1		HT75040T	\$42.15
3/4	4	300	240	CU-604-2		HT75040U	\$42.15
3/4	5	375	120	CU-605-1		HT75050L	\$48.65
3/4	5	375	240	CU-605-2		HT75050M	\$48.65
3/4	6	450	120	CU-606-1		HT75060N	\$55.20
3/4	6	450	240	CU-606-2		HT75060P	\$55.20
3/4	8	600	120	CU-608-1		HT75080W	\$68.30
3/4	8	600	240	CU-608-2		HT75080X	\$68.30
3/4	10	800	120	CU-610-1		HT75100P	\$81.35
3/4	10	800	240	CU-610-2		HT75100Q	\$81.35
3/4	12	950	120	CU-612-1		HT75120R	\$94.45
3/4	12	950	240	CU-612-2		HT75120S	\$94.45
3/4	14	1100	240	CU-614-2		HT75140J	\$107.55
3/4	16	1250	240	CU-616-2		HT75160F	\$120.60

DME Equivalent High Watt Density Heaters 10" Swaged with High Temperature Leads (Continued)

DIA	LENGTH	WATTS	VOLTS	DME PART	WATLOW PART	HTI PART	PRICE
1/4	1	100	120	CM-100-1	E1A52	HR25010J	\$17.95
1/4	1	100	240	CM-100-2	E1A66	HR25010K	\$17.95
1/4	1.5	150	120	CM-112-1	E1J41	HR25015L	\$19.30
1/4	1.5	150	240	CM-112-2		HR25015AU	\$19.30
1/4	2	200	120	CM-202-1	E2A57	HR25020R	\$21.10
1/4	2	200	240	CM-202-2	E2A50	HR25020S	\$21.10
1/4	3	300	120	CM-203-1	E3A350	HR25030K	\$24.25
1/4	3	300	240	CM-203-2	E3A51	HR25030L	\$24.25
1/4	4	375	240	CM-204-2		HR25040AR	\$27.40
1/4	5	450	240	CM-205-2		HR25050AP	\$30.55
3/8	2	250	240	CM-303-2	G2A73	HR37020U	\$21.60
3/8	3	350	240	CM-303-2		HR37030BM	\$25.15
3/8	4	500	240	CM-304-2	G4A92	HR37040AF	\$28.70
3/8	5	550	240	CM-305-2		HR37050BQ	\$32.25
3/8	6	500	240	CM-306-2	G6A59	HR37060AA	\$35.80
1/2	2	250	240	CM-402-2	J2A71	HR50020AB	\$24.50
1/2	3	300	240	CM-403-2	J3A73	HR50030T	\$29.20
1/2	4	400	240	CM-404-2	J4A6A	HR50040X	\$33.90
1/2	5	800	240	CM-405-2		HR50050AZ	\$38.55
1/2	6	1000	240	CM-406-2	J6A35	HR50060BZ	\$43.25
1/2	8	1200	240	CM-408-2		HR50080BR	\$52.65
1/2	10	1500	240	CM-410-2	J10A33	HR50100R	\$62.00
1/2	12	2000	240	CM-412-2	J12A89	HR50120N	\$71.40
5/8	2	300	240	CM-502-2		HR62020H	\$25.95
5/8	4	700	240	CM-504-2		HR62040AK	\$36.35
5/8	6	1000	240	CM-506-2	L6A71	HR62060K	\$46.75
5/8	8	1200	240	CM-508-2		HR62080AE	\$57.15
5/8	9	1400	240	CM-509-2		HR62090L	\$62.35
5/8	10	1500	240	CM-510-2	L10A8	HR62100G	\$67.55
5/8	14	2000	240	CM-514-2		HR62140P	\$88.35
3/4	2	300	240	CM-602-2		HR75020C	\$29.05
3/4	4	750	240	CM-604-2		HR75040F	\$42.15
3/4	6	1200	240	CM-606-2		HR75060Q	\$55.20

Hot Runner Heaters with Internal Thermocouples (Type J in Tip) 240V with 36" TC and Power Leads

DIA	LENGTH	WATTS	HTI PART	DME PART	INCOE PART	PRICE
1/4	1.5	200	HTR25015Y			\$60.55
1/4	1.75	200	HTR25017B			\$62.35
1/4	2	200	HTR25020AC			\$62.35
1/4	2.5	200	HTR25025P			\$65.50
1/4	3	200	HTR25030U			\$65.50
1/4	3.5	250	HTR25035E			\$68.65
1/4	4	250	HTR25040V			\$68.65
1/4	5	250	HTR25050AB			\$71.80
3/8	1.75	200	HTR37017N	TCH0001	TJ38017	\$63.65
3/8	2	250	HTR37020AQ	TCH0002	TJ38020	\$63.65
3/8	2.5	250	HTR37025T	TCH0003	TJ38025	\$67.20
3/8	3	250	HTR37030AQ	TCH0004	TJ38030	\$67.20
3/8	3.5	320	HTR37035P	TCH0005	TJ38035	\$70.75
3/8	4	370	HTR37040BB	TCH0006	TJ38040	\$70.75
3/8	4.5	420	HTR37045N	TCH0007	TJ38045	\$74.30
3/8	5	470	HTR37050AZ	TCH0008	TJ38050	\$74.30
3/8	5.5	525	HTR37055G	TCH0009	TJ38055	\$77.85
3/8	6	575	HTR37060AN	TCH0010	TJ38060	\$77.85
3/8	6.5	625	HTR37065F	TCH0011	TJ38065	\$81.40
3/8	7	675	HTR37070N	TCH0012	TJ38070	\$81.40
3/8	7.5	725	HTR37075D	TCH0013	TJ38075	\$84.95
3/8	8	775	HTR37080AL	TCH0014	TJ38080	\$84.95
1/2	3.5	420	HTR50035N	TCH0015	TJ12035	\$75.95
1/2	4	480	HTR50040AL	TCH0016	TJ12040	\$75.95
1/2	4.5	550	HTR50045J	TCH0017	TJ12045	\$80.65
1/2	5	625	HTR50050AF	TCH0018	TJ12050	\$80.65
1/2	5.5	700	HTR50055G	TCH0019	TJ12055	\$85.30
1/2	6	775	HTR50060AQ	TCH0020	TJ12060	\$85.30
1/2	6.5	850	HTR50065D	TCH0021	TJ12065	\$90.00
1/2	7	900	HTR50070N		TJ12070	\$90.00
1/2	7.5	975	HTR50075D	TCH0022	TJ12075	\$94.70
1/2	8	1050	HTR50080AT			\$94.70
1/2	8.5	1100	HTR50085G			\$99.40
1/2	9	1200	HTR50090P		TJ12090	\$99.40
1/2	9.5	1250	HTR50095B			\$104.05
1/2	10	1325	HTR50100AJ			\$104.05
1/2	10.5	1400	HTR50105A			\$108.75
1/2	11.5	1525	HTR50115B			\$113.45

.25" Probe Heaters with Thermocouple (Type J in Tip) 240V with 36" TC and Power Leads

LENGTH (IN)	WATTS	DME PART	HTI PART	PRICE
2	200	AFTC-202-2	HR25020AC	\$62.35
3	300	AFTC-203-2	HR25030AV	\$65.50
3	150	AFTC-213-2	HR25030AW	\$65.50
3.75	220	AFTC-214-2	HR25037E	\$68.65
4	375	AFTC-204-2	HR25040AS	\$68.65
4.75	275	AFTC-215-2	HR25047E	\$71.80
5	475	AFTC-205-2	HR25050AQ	\$71.80
5.75	350	AFTC-216-2	HR25057B	\$74.95

.25" Probe Heaters without Thermocouple 240V with 10" Power Leads

LENGTH (IN)	WATTS	DME PART	HTI PART	PRICE
2	200	AFC-202-2	HR25020S	\$21.10
3	300	AFC-203-2	HR25030L	\$24.25
3	150	AFC-213-2	HR25030AX	\$24.25
3.75	220	AFC-214-2	HR25037F	\$27.40
4.75	275	AFC-215-2	HR25047F	\$30.55
5.75	350	AFC-216-2	HR25057C	\$33.70

.375" Probe Heaters with Thermocouple (Type J in Tip) 230v with 36" TC and Power Leads

LENGTH (IN)	WATTS	VOLTS	DME PART	HTI PART	LIST PRICE
1.5	200	230		HTIC-150-2	\$38.00
1.75	200	230		HTIC-175-2	\$38.00
2	200	230	AFTC-201-2	HTIC -201-2	\$38.00
3	200	230	AFTC-202-2	HTIC -202-2	\$39.00
3	300	230	AFTC-203-2	HTIC -203-2	\$39.00
3.75	150	230	AFTC-213-2	HTIC -213-2	\$39.00
4	220	230	AFTC-214-2	HTIC -214-2	\$39.00
4.75	375	230	AFTC-204-2	HTIC -204-2	\$40.00
5	275	230	AFTC-215-2	HTIC -215-2	\$40.00
5.75	475	230	AFTC-205-2	HTIC -205-2	\$40.00

.375" Probe Heaters with Thermocouple (Type J in Tip) 230v with 36" TC and Power Leads

LENGTH (IN)	WATTS	VOLTS	DME PART	HTI PART	LIST PRICE
1.75	200	230	TCH0001	HHPC 0001	\$ 35.00
2	250	230	TCH0002	HHPC 0002	\$ 35.00
2.5	250	230	TCH0003	HHPC 0003	\$ 37.00
3	250	230	TCH0004	HHPC 0004	\$ 37.00
3.5	320	230	TCH0005	HHPC 0005	\$ 37.00
4	370	230	TCH0006	HHPC 0006	\$ 37.50
4.5	420	230	TCH0007	HHPC 0007	\$ 38.00
5	470	230	TCH0008	HHPC 0008	\$ 38.00
5.5	525	230	TCH0009	HHPC 0009	\$ 38.00
6	575	230	TCH0010	HHPC 0010	\$ 39.00
6.5	625	230	TCH0011	HHPC 0011	\$ 39.00
7	675	230	TCH0012	HHPC 0012	\$ 42.00
7.5	725	230	TCH0013	HHPC 0013	\$ 42.00
8	775	230	TCH0014	HHPC 0014	\$ 42.00
7.19	645	230	AFTC-327-2	HHPC -327-2	\$ 42.00
8.19	760	230	AFTC-328-2	HHPC -328-2	\$ 42.00
9.19	870	230	AFTC-329-2	HHPC -329-2	\$ 44.50
10.19	980	230	AFTC-3210-2	HHPC -3210-2	\$ 45.00

.5" Hot Runner Heaters with Thermocouple (Type J in Tip) 230V with 36" TC and Power Leads

LENGTH (IN)	WATTAGE	VOLTS	DME PART	HTI PART	LIST PRICE
3.5	420	230	TCH0015	CH0015	\$41.00
4	480	230	TCH0016	CH0016	\$41.00
4.5	550	230	TCH0017	CH0017	\$41.00
5	625	230	TCH0018	CH0018	\$44.00
5.5	700	230	TCH0019	CH0019	\$44.00
6	775	230	TCH0020	CH0020	\$44.00
6.5	850	230	TCH0021	CH0021	\$46.00
7	900	230		CH0021-2	\$49.00
7.5	975	230	TCH0022	CH0022	\$49.00
8	1050	230		CH0023	\$50.00
8.5	1100	230		CH0024	\$51.00
9	1200	230		CH0025	\$52.00
9.5	1250	230		CH0026	\$53.00
10	1325	230		CH0027	\$54.00
10.5	1400	230		CH0028	\$56.00
11.5	1525	230		CH0029	\$58.00

.5" Diameter Tube Heaters with Thermocouple (Type J Centered) 240v with 36" TC and Power Leads

LENGTH (IN)	WATTS	VOLTS	DME PART	HTI PART	PRICE
4.000	380	230	HCTC-04-4	HHPC-04-4	\$38.50
5.000	500	230	HCTC-04-5	HHPC-04-5	\$39.00
6.000	600	230	HCTC-04-6	HHPC-04-6	\$40.50
7.000	700	230	HCTC-04-7	HHPC-04-7	\$43.00
8.000	820	230	HCTC-04-8	HHPC-04-8	\$43.00
9.000	920	230	HCTC-04-9	HHPC-04-9	\$47.50
10.000	1030	230	HCTC-04-10	HHPC-04-10	\$47.50
11.000	1140	230	HCTC-04-11	HHPC-04-11	\$50.00
12.000	1250	230	HCTC-04-12	HHPC-04-12	\$50.00
13.000	1350	230	HCTC-04-13	HHPC-04-13	\$52.00
14.000	1460	230	HCTC-04-14	HHPC-04-14	\$55.00
15.000	1570	230	HCTC-04-15	HHPC-04-15	\$57.00
16.000	1680	230	HCTC-04-16	HHPC-04-16	\$58.00
17.000	1780	230	HCTC-04-17	HHPC-04-17	\$60.00
18.000	1900	230	HCTC-04-18	HHPC-04-18	\$62.00
19.000	2010	230	HCTC-04-19	HHPC-04-19	\$62.00
20.000	2110	230	HCTC-04-20	HHPC-04-20	\$64.00
21.000	2220	230	HCTC-04-21	HHPC-04-21	\$66.00
22.000	2330	230	HCTC-04-22	HHPC-04-22	\$68.00
23.000	2400	230	HCTC-04-23	HHPC-04-23	\$70.00
24.000	2400	230	HCTC-04-24	HHPC-04-24	\$72.00
25.000	2400	230	HCTC-04-25	HHPC-04-25	\$74.00
26.000	2400	230	HCTC-04-26	HHPC-04-26	\$76.00
27.000	2400	230	HCTC-04-27	HHPC-04-27	\$78.00
28.000	2400	230	HCTC-04-28	HHPC-04-28	\$80.00
29.000	2400	230	HCTC-04-29	HHPC-04-29	\$ 82.00
30.000	2400	230	HCTC-04-30	HHPC-04-30	\$84.00

.625" Diameter Tube Heaters with Thermocouple (Type J Centered) 240v with 36" TC and Power Leads

LENGTH (IN)	WATTS	VOLTS	DME PART	HTI PART	LIST PRICE
5	620	230	HCTC-05-5	HHPC-05-5	\$43.00
6	750	230	HCTC-05-6	HHPC-05-6	\$45.00
7	880	230	HCTC-05-7	HHPC-05-7	\$49.50
8	1020	230	HCTC-05-8	HHPC-05-8	\$49.50
9	1160	230	HCTC-05-9	HHPC-05-9	\$53.50
10	1300	230	HCTC-05-10	HHPC-05-10	\$54.00
11	1430	230	HCTC-05-11	HHPC-05-11	\$56.50
12	1570	230	HCTC-05-12	HHPC-05-12	\$56.50
13	1700	230	HCTC-05-13	HHPC-05-13	\$64.00
14	1840	230	HCTC-05-14	HHPC-05-14	\$64.00
15	1980	230	HCTC-05-15	HHPC-05-15	\$65.00
16	2110	230	HCTC-05-16	HHPC-05-16	\$65.00
17	2250	230	HCTC-05-17	HHPC-05-17	\$70.50
18	2390	230	HCTC-05-18	HHPC-05-18	\$70.50
19	2525	230	HCTC-05-19	HHPC-05-19	\$75.00
20	2660	230	HCTC-05-20	HHPC-05-20	\$75.00
21	2800	230	HCTC-05-21	HHPC-05-21	\$78.00
22	2930	230	HCTC-05-22	HHPC-05-22	\$78.50
23	3070	230	HCTC-05-23	HHPC-05-23	\$81.50
24	3200	230	HCTC-05-24	HHPC-05-24	\$84.50
25	3340	230	HCTC-05-25	HHPC-05-25	\$87.00
26	3480	230	HCTC-05-26	HHPC-05-26	\$89.50
27	3620	230	HCTC-05-27	HHPC-05-27	\$92.00
28	3750	230	HCTC-05-28	HHPC-05-28	\$95.50
29	3900	230	HCTC-05-29	HHPC-05-29	\$98.00
30	4030	230	HCTC-05-30	HHPC-05-30	\$100.00
32	4300	230	HCTC-05-32	HHPC-05-32	\$105.00
36	4840	230	HCTC-05-36	HHPC-05-36	\$108.00

OEM Incoe Probe Heaters with Thermocouple (Type J in Tip) 230v with 36" TC and Power Leads

DIAMETER (IN)	LENGTH (IN)	WATTS	DME PART	HTI PART	PRICE
0.375	1.75	200	TJ38017	HTJ38017	\$35.00
0.375	2	250	TJ38020	HTJ38020	\$35.00
0.375	2.5	250	TJ38025	HTJ38025	\$37.00
0.375	3	260	TJ38030	HTJ38030	\$37.00
0.375	3.5	320	TJ38035	HTJ38035	\$38.00
0.375	4	370	TJ38040	HTJ38040	\$38.00
0.375	4.5	420	TJ38045	HTJ38045	\$39.00
0.375	5	470	TJ38050	HTJ38050	\$40.00
0.375	5.5	525	TJ38055	HTJ38055	\$40.00
0.375	6	575	TJ38060	HTJ38060	\$40.00
0.375	6.5	625	TJ38065	HTJ38065	\$42.00
0.375	7	675	TJ38070	HTJ38070	\$42.00
0.375	7.5	725	TJ38075	HTJ38075	\$42.00
0.375	8	775	TJ38080	HTJ38080	\$42.00
0.375	9	885	TJ38090	HTJ38090	\$45.00
0.375	9.5	940	TJ38095	HTJ38095	\$45.00
0.375	10	990	TJ38100	HTJ38100	\$46.00
0.5	2.5	280	TJ12025	HTJ12025	\$41.00
0.5	3.5	420	TJ12035	HTJ12035	\$41.00
0.5	4	490	TJ12040	HTJ12040	\$41.00
0.5	4.5	550	TJ12045	HTJ12045	\$44.00
0.5	5	625	TJ12050	HTJ12050	\$44.00
0.5	5.5	700	TJ12055	HTJ12055	\$44.00
0.5	6	775	TJ12060	HTJ12060	\$46.00
0.5	6.5	850	TJ12065	HTJ12065	\$49.00
0.5	7.5	975	TJ12075	HTJ12075	\$49.00
0.5	8.5	1100	TJ12085	HTJ12085	\$50.00
0.5	9.5	1250	TJ12095	HTJ12095	\$51.00

High-Temp Industries

Other Quality Products



Cartridge Heaters



Split Sheath Heaters



Cast in Coil Heaters



Platinum Heaters



Nozzle Heaters



Cast Heaters



Tubular Heaters



Ceramic Band Heaters



PID Controllers



Thermocouples



Hot Runner Cables



Hot Runner Controllers

And more.....www.high-temp.com