

High-Temp Industries

Superior Quality
Comprehensive Services
Unequaled Value

Coil Heaters 2012

Phone 215-794-0864

Fax 215-794-7583

www.high-temp.com

Table of Contents

Husky Replacement Heaters.....	3
Husky 500 Series	3
Husky 1250 Series	4
Husky 750 Series	5
Incoe Replacement Heaters.....	6
Incoe XH Series.....	6
Incoe XRC Series.....	7
Incoe XRH Series	7
Incoe KH Series.....	8
Incoe XH Series.....	9
Axial Lock-Up Mini Heaters.....	10
DME Replacement Heaters.....	11
DME Flow through Type - Hot Sprue Bushings.....	11
DME Heated Nozzle Locators.....	12
DME Externally Heated Manifold Systems	13
High-Temp Custom Coil Heaters.....	14
Technical Specifications	15
Optional Cross Sections	15
Lead Protection Options	15
Exit Styles and Specifications	16
Stock HTI Coil Heaters.....	17
Maxi Replacement Heaters.....	18
Coil Heaters - Stock and Popular Sizes.....	19
.5" Internal Diameter	19
.625" Internal Diameter	20
.75" Internal Diameter	21
.875" Internal Diameter	21
1" Internal Diameter	21
1.125" Internal Diameter	21
1.25" Internal Diameter	21
1.375" Internal Diameter	21
1.5" Internal Diameter	21

Husky Replacement Heaters

High-Temp Industries offers direct replacements for Husky heating elements. 100% interchangeable with OEM parts, all heating elements are manufactured to higher quality standards to provide superior performance, while also providing a more cost-effective option over typical Husky pricing. The elements utilize the same thermocouple and retaining caps with a tolerance of +/- 2% at 240v. Flexible element extensions terminate to standard Teflon 72 inch lead wires with moisture resistant seals to ensure longevity. All of our replacement heating elements come with a 1 year warranty against manufacturing defects and are **in stock and ready to ship**.

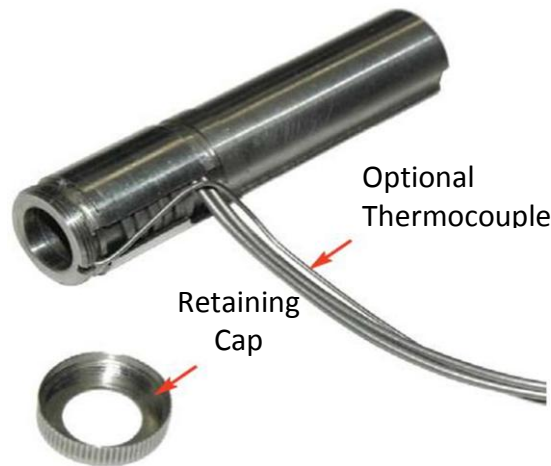

Husky 500 Series

HTI PART #	OEM PART #	ID IN	LENGTH	WATTAGE	VOLTS	PRICE
HT50-75-30		0.5	30MM	280	240	\$86.00
HT50-75-40		0.5	40MM	280	240	\$91.00
HT50-75-50		0.5	50MM	280	240	\$95.00
HT50-75-60	2343737	0.5	60MM	280	240	\$99.00
HT50-75-70	2343738	0.5	70MM	280	240	\$103.00
HT50-75-80	2343739	0.5	80MM	280	240	\$107.00
HT50-75-90	2343740	0.5	90MM	280	240	\$123.00
HT50-75-100	2343741	0.5	100MM	280	240	\$133.00
HT50-75-110	2343742	0.5	110MM	280	240	\$139.00
HT50-75-120	2343743	0.5	120MM	280	240	\$145.00
HT50-75-130	2343744	0.5	130MM	280	240	\$154.00
HT-50-75-140	2343745	0.5	140MM	280	240	\$165.00



Husky 1250 Series

HTI PART #	OEM PART #	ID IN	LENGTH	WATTAGE	VOLTS	PRICE
HT125-75-44	535069	1.25"	1.73"	400	230	\$125.00
HT125-75-54		1.25"	2.12"	400	230	\$135.00
HT125-75-64		1.25"	2.51"	400	230	\$143.95

Husky Replacement Heaters



Husky 750 Series

HTI PART #	OEM PART #	T/C P/N	ID MM	LENGTH MM	WATTAGE	VOLTAGE	PRICE
HTN491	534975	535038	19.05mm(3/4")	30mm	220W	240V	\$86.00
HTN492	534976	535037	19.05mm(3/4")	40mm	220W	240V	\$91.00
HTN493	534977	535037	19.05mm(3/4")	50mm	220W	240V	\$95.00
HTN494	534978	535037	19.05mm(3/4")	60mm	220W	240V	\$99.00
HTN495	534979	535037	19.05mm(3/4")	70mm	220W	240V	\$103.00
HTN496	534980	535002	19.05mm(3/4")	80mm	220W	240V	\$107.00
HTN497	534981	535002	19.05mm(3/4")	90mm	220W	240V	\$115.00
HTN498	534982	535002	19.05mm(3/4")	100mm	220W	240V	\$123.00
HTN499	534983	535002	19.05mm(3/4")	110mm	220W	240V	\$133.00
HTN500		535681	19.05mm(3/4")	120mm	220W	240V	\$139.00
HTN501	535470	535681	19.05mm(3/4")	130mm	220W	240V	\$145.00
HTN502	535471	535681	19.05mm(3/4")	150mm	220W	240V	\$159.00
HTN503	535472	535681	19.05mm(3/4")	170mm	220W	240V	\$175.00
HTN504	535473	535709	19.05mm(3/4")	190mm	220W	240V	\$193.00
HTN505	535474	535709	19.05mm(3/4")	210mm	220W	240V	\$214.00
HTN506	1501609	535038	19.05mm(3/4")	30mm	350W	240V	\$86.00
HTN507	1502992	535037	19.05mm(3/4")	40mm	350W	240V	\$91.00
HTN508	1045865	535037	19.05mm(3/4")	50mm	350W	240V	\$95.00
HTN509	1501594	535037	19.05mm(3/4")	60mm	400W	240V	\$99.00
HTN510	1502994	535037	19.05mm(3/4")	70mm	400W	240V	\$103.00
HTN511	1501595	535002	19.05mm(3/4")	80mm	400W	240V	\$107.00
HTN512	1502995	535002	19.05mm(3/4")	90mm	400W	240V	\$115.00
HTN513	1501596	535002	19.05mm(3/4")	100 mm	400W	240V	\$123.00
HTN514		535002	19.05mm(3/4")	100mm	450W	240V	\$123.00
HTN515	1502996	535038	19.05mm(3/4")	110mm	400W	240V	\$133.00
HTN516		535681	19.05mm(3/4")	120mm	400W	240V	\$139.00
HTN517		535681	19.05mm(3/4")	120mm	400W	240V	\$139.00
HTN518	1502997	535681	19.05mm(3/4")	130mm	400W	240V	\$145.00
HTN519	1502998	535681	19.05mm(3/4")	150mm	450W	240V	\$159.00
HTN520	1502999	535709	19.05mm(3/4")	170mm	450W	240V	\$175.00
HTN521	1503000		19.05mm(3/4")	190mm	450W	240V	\$193.00
HTN522	1503001		19.05mm(3/4")	210 mm	450W	240V	\$214.00
HTN1212	535181		Cap				\$6.25

Incoe Replacement Heaters

High-Temp Industries offers direct replacements for Incoe Hot Runner heaters that are 100% interchangeable with OEM parts, including the acceptance of the same thermocouple via the internal 1mm x 1mm groove. All heaters are manufactured to higher quality standards, including improvements to overall performance that provides superior heat transfer and heat distribution to the nozzle assembly to provide superior performance, while also providing a more cost-effective option over typical Incoe pricing. Flexible element extensions terminate to lead wires with moisture resistant seals to ensure longevity. All of our replacement heating elements come with a 1 year warranty against manufacturing defects and are **in stock and ready to ship**.



Incoe XH Series 1.25" ID

HTI PART #	INCOE PART #	ID MM	OD MM	OD Inch	LENGTH MM	LENGTH Inch	LEAD Inch	VOLTAGE	WATTAGE	PRICE
KX-32011	XH-1250	31.86	47.5	1.87	124	4.88	48	230	850	\$256.00
KX-32012		31.86	47.5	1.87	134	5.27	48	230	850	\$278.00
KX-32013		31.86	47.5	1.87	144	5.66	48	230	850	\$288.00
KX-32014		31.86	47.5	1.87	154	6.06	48	230	850	\$299.00
KX-32015		31.86	47.5	1.87	164	6.45	48	230	850	\$311.00
KX-32016		31.86	47.5	1.87	174	6.85	48	230	850	\$323.00
KX-32017		31.86	47.5	1.87	184	7.24	48	230	850	\$339.00
KX-32018		31.86	47.5	1.87	194	7.63	48	230	850	\$346.00
KX-32019		31.86	47.5	1.87	204	8.03	48	230	850	\$355.00
KX-32020		31.86	47.5	1.87	214	8.42	48	230	850	\$367.00
KX-32021	XH-1288	31.86	47.5	1.87	224	8.81	48	230	850	\$375.00

Incoe Replacement Heaters



Incoe XRC Series .875" ID

HTI PART #	INCOE PART #	ID MM	ID INCH	OD MM	OD INCH	LENGTH MM	LENGTH INCH	LEAD INCH	VOLTAGE	WATTAGE	PRICE
K-22067	XRC-8270	22.6	0.875	38	1.49	67	2.63	48	230	550	\$265.00
K-22080	XRC-8320	22.6	0.875	38	1.49	80	3.14	48	230	550	\$281.00
K-22092	XRC-8370	22.6	0.875	38	1.49	92	3.62	48	230	550	\$299.00
K-22110	XRC-8440	22.6	0.875	38	1.49	110	4.33	48	230	550	\$310.00
K-22135	XRC-8540	22.6	0.875	38	1.49	135	5.31	48	230	650	\$325.00
K-22160	XRC-8540	22.6	0.875	38	1.49	160	6.29	48	230	850	\$350.00



Incoe XRH Series .5" ID

HTI PART #	INCOE PART #	ID MM	ID INCHES	OD MM	OD INCHES	LENGTH MM	LENGTH INCHES	LEAD INCHES	VOLTAGE	WATTAGE	PRICE
HTI-5260	XRH 5260	12.7	.5	24.5	0.96	66	2.6	48	230	460	\$275.00
HTI-5360	XRH 5360	12.7	.5	24.5	0.96	92	3.6	48	230	480	\$299.00
HTI-5460	XRH 5460	12.7	.5	24.5	0.96	115	4.6	48	230	530	\$303.00
HTI-5560	XRH 5560	12.7	.5	24.5	0.96	142	5.6	48	230	550	\$333.00
HTI-5660	XRH 5660	12.7	.5	24.5	0.96	168	6.6	48	230	600	\$350.00
HTI-5760	XRH 5760	12.7	.5	24.5	0.96	193	7.6	48	230	650	\$375.00

Incoe Replacement Heaters

Incoe KH Series

HTI PART#	OEM PART#	IO IN	OD IN	WIDTH IN	WATTS	VOLTS	DISTRIBUTED WATTAGE	PRICE
HKC-52030	KH-52030	0.5	0.808	3	380	240	YES	\$102.00
HKC-52035	KH-52035	0.5	0.808	3.5	380	240	YES	\$112.00
HKC-53545	KH-53545	0.5	0.764	4.5	400	240	YES	\$123.00
HKC-53555	KH-53555	0.5	0.75	5.5	400	240	YES	\$145.00
HKC-53565	KH-53565	0.5	0.75	6.5	400	240	YES	\$102.00
HKC-520	KH-520	0.5	0.764	2	340	120	YES	\$102.00
HKC-52025	KH-52025	0.5	0.764	2.5	340	120	YES	\$112.00
HKC-52030	KH-52030	0.5	0.764	3	380	120	YES	\$123.00
HKC-52035	KH-52035	0.5	0.764	3.5	380	120	YES	\$145.00
HKC-53045	KH-53045	0.5	0.744	4.5	400	120	YES	\$123.00
HKC-53055	KH-53055	0.5	0.744	5.5	400	120	YES	\$112.00
HKC-53065	KH-53065	0.5	0.744	6.5	400	120	YES	\$123.00
HKC-826	KH-826	0.875	1.181	2.625	480	240	YES	\$145.00
HKC-82630	KH-82630	0.875	1.181	3.125	480	240	YES	\$135.00
HKC-82636	KH-82636	0.875	1.181	3.625	550	240	YES	\$145.00
HKC-82640	KH-82640	0.875	1.181	4.3125	550	240	YES	\$112.00
HKC-82650	KH-82650	0.875	1.181	5.3125	650	240	YES	\$123.00
HKC-82660	KH-82660	0.875	1.181	6.3125	650	240	YES	\$145.00
HKC-82670	KH-82670	0.875	1.181	7.3125	650	240	YES	\$135.00
HKC-84380	KH-84380	0.875	1.105	8.3125	730	240	YES	\$145.00
HKC-84390	KH-84390	0.875	1.105	9.3125	730	240	YES	\$135.00
HKC-84310	KH-84310	0.875	1.105	10.3125	850	240	YES	\$145.00
HKC-85311	KH-85311	0.875	1.105	11.3125	850	240	YES	\$165.00
HKC-85312	KH-85312	0.875	1.105	12.3125	850	240	YES	\$189.00
HKC-85313	KH-85313	0.875	1.105	13.3125	850	240	YES	\$189.00
HKC-85314	KH-85314	0.875	1.105	14.3125	850	240	YES	\$165.00
HKC-1225	KH-1225	1.25	1.48	2.5	750	240	YES	\$175.00
HKC-1245	KH-1245	1.25	1.514	4.5	1250	240	YES	\$189.00
HKC-1265	KH-1265	1.25	1.534	6.5	1800	240	YES	\$189.00
HKC-1285	KH-1285	1.25	1.594	8.5	2335	240	YES	\$189.00
HKC-12105	KH-12105	1.25	1.626	10.5	2500	240	YES	\$210.00

.086" X .165" rectangular cross section

48" Teflon leads stainless steel armor cable protection

Incoe Replacement Heaters



Incoe XH Series .315" ID

HTI PART #	INCOE PART #	ID MM	ID INCHES	OD MM	OD INCHES	LENGTH MM	LENGTH INCHES	LEAD INCHES	VOLTAGE	WATTAGE	PRICE
HTI-842	XH-842	8mm	0.315	14.35	0.565	42	1.65	48	230	180	\$265.00
HTI-862	XH-862	8mm	0.315	14.35	0.565	62	2.44	48	230	220	\$281.00
HTI-882	XH-882	8mm	0.875	14.35	0.565	82	3.22	48	230	250	\$299.00

Axial Lock-Up Mini Heaters



The mini-coil heater with our axial clamping strap allows the heating element to maintain full clamping force at elevated temperatures. Our wedge locking mechanism compensates for thermal expansion ensuring optimum performance at high temperatures. The mini coil heating element is constructed in a rectangular profile to increase surface contact of the heater and injection nozzle, resulting in superior heat transfer. Flexible element extensions terminate to standard Teflon 72 inch lead wires with moisture resistant seals to ensure longevity. Tolerances of +/- 2% at 240v. All of our replacement heating elements come with a 1 year warranty against manufacturing defects and are **in stock and ready to ship**.

HTI PART #	CLAMP TYPE	ID INCHES	LENGTH INCHES	ID MM	LENGTH MM	WIRE PROFILE	WATTAGE	PRICE
HTI-095	Axial Wedge	0.625	1	15.88	25.4	Flat	125	\$82.00
HTI-096	Axial Wedge	0.625	1	15.88	25.4	Flat	250	\$82.00
HTI-097	Axial Wedge	0.625	1.5	15.88	38.1	Flat	250	\$88.00
HTI-098	Axial Wedge	0.625	2	15.88	50.8	Flat	149	\$94.00
HTI-099	Axial Wedge	0.75	1	19.05	25.4	Flat	125	\$82.00
HTI-100	Axial Wedge	0.75	1.2	19.05	30.5	Flat	125	\$86.00
HTA-101	Axial Wedge	0.75	1.2	19.05	30.5	Flat	149	\$86.00
HTI-102	Axial Wedge	0.75	1.2	19.05	30.5	Flat	175	\$86.00
HTI-103	Axial Wedge	0.75	1.2	19.05	30.5	Flat	268	\$86.00
HTI-104	Axial Wedge	0.75	1.5	19.05	38.1	Flat	300	\$88.00
HTI-105	Axial Wedge	0.875	0.9	22.23	22.9	Flat	149	\$92.00
HTI-106	Axial Wedge	0.875	0.9	22.23	22.9	Flat	175	\$92.00
HTI-107	Axial Wedge	0.875	0.9	22.23	22.9	Flat	300	\$92.00
HTI-108	Axial Wedge	0.875	1.2	22.23	30.5	Flat	149	\$96.00
HTI-109	Axial Wedge	0.875	1.2	22.23	30.5	Flat	175	\$96.00
HTI-110	Axial Wedge	0.875	1.2	22.23	30.5	Flat	250	\$96.00
HTI-111	Axial Wedge	0.875	1.2	22.23	30.5	Flat	268	\$96.00
HTI-112	Axial Wedge	0.875	1.5	22.23	38.1	Flat	250	\$98.00
HTI-113	Axial Wedge	0.875	2	22.23	50.8	Flat	175	\$104.00
HTI-114	Axial Wedge	0.875	2	22.23	50.8	Flat	250	\$104.00
HTI-115	Axial Wedge	0.875	2	22.23	50.8	Flat	250	\$104.00
HTI-116	Axial Wedge	0.875	2	22.23	50.8	Flat	400	\$104.00
HTI-117	Axial Wedge	0.875	3.5	22.23	88.9	Flat	268	\$128.00
HTI-118	Axial Wedge	1	1.2	25.4	30.5	Flat	250	\$128.00
HTI-119	Axial Wedge	1	1.2	25.4	30.5	Flat	350	\$128.00
HTI-120	Axial Wedge	1	1.2	25.4	30.5	Flat	400	\$128.00
HTI-121	Axial Wedge	1	1.2	25.4	30.5	Flat	400	\$128.00
HTI-122	Axial Wedge	1	2	25.4	50.8	Flat	250	\$138.00
HTI-123	Axial Wedge	1	2	25.4	50.8	Flat	375	\$138.00
HTI-124	Axial Wedge	1.25	1.2	31.75	30.5	Flat	250	\$138.00
HTI-125	Axial Wedge	1.25	2	31.75	50.8	Flat	250	\$143.00
HTI-126	Axial Wedge	1.5	0.95	38.1	24.1	Flat	275	\$143.00

DME Replacement Heaters



Designed to exceed the Original manufacturer quality, we provide direct replacement heaters for DME hot runner and sprues. Manufactured to provide unparalleled performance, while providing a more cost effective replacement element over DME pricing. Tolerances of +/- 2% at 240v. Our replacement heating elements come with a 1 year warranty against manufactured defects and are in **stock ready to ship**.

DME Flow through Type - Hot Sprue Bushings

HTI PART #	OEM PART #	COIL ID IN	COIL LENGTH IN	TC	VOLTAGE	WATTAGE	PRICE
HTTC-31	SSTC-31	0.500"	4.625"	YES	240	300	\$102.00
HTTC-32	SSTC-32	0.500"	4.625"	YES	240	300	\$102.00
HTTC-42	SSTC-42	0.500"	2.50"	YES	240	450	\$102.00
HTTC-31-90	SSTC-31-90	0.500"	4.625"	YES	240	300	\$102.00
HTTC-32-90	SSTC-32-90	0.500"	4.625"	YES	240	300	\$102.00
HTTC-42-90	SSTC-42-90	0.500"	2.50"	YES	240	450	\$102.00

1/8" square cross section profile

Type J ungrounded thermocouple junction at tip location

48" Teflon leads with stainless steel armor cable protection

HTI PART #	OEM PART #	COIL ID IN	COIL LENGTH IN	TC	VOLTAGE	WATTAGE	PRICE
HTHC00001	SCH0001	1.25	2.625	NO	240	800	\$210.00
HTHC00002	SCH0002	1.25	1.75	NO	240	600	\$169.00
HTHC00003	SCH0003	.625	1	NO	240	225	\$102.25
HTHC00004	SCH3142	.750	1.75	NO	240	315	\$123.50
HTHC00005	SCH3242	.750	2.625	NO	240	315	\$123.50

.110" X .160" rectangular profile or 1/8" square profile option

No thermocouple

48" Teflon leads with high temperature fiberglass sleeving

DME Replacement Heaters

DME Heated Nozzle Locators

HTI PART #	OEM PART #	COIL ID IN	COIL LENGTH IN	TC	VOLTAGE	WATTAGE	PRICE
HTH1060	SCH0060	0.750"	1.594"	YES	240	250	\$102.25
HTH1061	SCH0061	0.750"	2.094"	YES	240	300	\$120.50
HTH1062	SCH0062	0.750"	2.594"	YES	240	350	\$130.50
HTH1063	SCH0063	0.750"	3.094"	YES	240	400	\$140.95
HTH1064	SCH0064	0.750"	3.594"	YES	240	425	\$141.90
HTH1065	SCH0065	0.750"	4.594"	YES	240	500	\$169.00
HTH1066	SCH0066	0.750"	5.594"	YES	240	500	\$169.00
HTH0103	SCH0103	0.750"	1.0"	NO	240	125	\$86.00
HTH0104	SCH0104	0.750"	1.0"	NO	240	125	\$86.00
HTH0105	SCH0105	0.750"	1.0"	NO	240	250	\$86.00
HTH0106	SCH0106	0.750"	1.0"	NO	240	250	\$86.00
HTH0107	SCH0107	0.750"	1.0"	YES	240	125	\$86.00
HTH0108	SCH0108	0.750"	1.0"	NO	240	250	\$86.00
HTH0109	SCH0109	0.875"	1.0"	NO	240	125	\$86.00
HTH0110	SCH0110	0.875"	1.0"	NO	240	250	\$86.00

.110" X .160" rectangular profile or 1/8" square profile option
 Type J ungrounded thermocouple junction at tip of coil heater
 48" Teflon leads with stainless steel wire braid

DME Replacement Heaters

DME Externally Heated Manifold Systems

HTI PART #	OEM PART #	COIL ID IN	COIL LENGTH IN	TC	VOLTS	WATTS	PRICE
HTCH0081	SCH0081	0.625	2	YES	240	300	\$99.00
HTCH0082	SCH0082	0.625	2.5	YES	240	350	\$125.50
HTCH0083	SCH0083	0.625	3	YES	240	400	\$130.90
HTCH0084	SCH0084	0.625	3.5	YES	240	425	\$141.90
HTCH0085	SCH0085	0.625	4	YES	240	500	\$150.00
HTCH0086	SCH0086	0.625	5	YES	240	500	\$165.00
HTCH0087	SCH0087	0.625	6	YES	240	550	\$180.25

HTI PART #	OEM PART #	COIL ID IN	COIL LENGTH IN	TC	VOLTS	WATTS	PRICE
HTCH0088	SCH0088	0.875	2.125	YES	240	400	\$128.50
HTCH0089	SCH0089	0.875	2.625	YES	240	450	\$139.50
HTCH0090	SCH0090	0.875	3.125	YES	240	550	\$150.00
HTCH0091	SCH0091	0.875	3.625	YES	240	700	\$172.50
HTCH0092	SCH0092	0.875	4.125	YES	240	800	\$188.90
HTCH0093	SCH0093	0.875	5.125	YES	240	900	\$198.25
HTCH0094	SCH0094	0.875	6.125	YES	240	1000	\$210.00
HTCH0095	SCH0095	0.875	7.125	YES	240	1100	\$243.00

.110" X .160" rectangular profile or 1/8" square profile option

No thermocouple

48" Teflon leads with high temperature fiberglass sleeving



High-Temp Custom Coil Heaters



High-Temp Industries has the capabilities to supply you with virtually any shape, size or configuration of coil heater to meet your precise requirements. Our coil heaters are small-diameter, high-performance units that are fully annealed and ready to bend into variety of custom designs. The heater can be formed into a compact, coiled nozzle to supply a full 360° of heat with optional distributed wattage. Coil heaters can be utilized for just about any application that requires high heat but has space limitations. Different applications require different fabrication methods, including: one, two or four resistance wires; parallel coil or straight wire; drawn or swaged sheaths; with or without internal thermocouples; leads exiting from one or both ends; cast or embedded in brass or copper; and/or round, rectangular or square cable cross sectionals. Whatever the application, High-Temp Industries' coil heaters are a superior quality product that can be fabricated to ensure your success; all at an affordable price.

Applications:

- Plastic injection molding nozzles
- Hot metal forming dies and punches
- Sealing and cutting bars
- Medical, analytical and scientific instruments
- Restaurant and food processing equipment
- Laminating and printing presses
- Air heating
- Heating in a vacuum environment



Technical Specifications

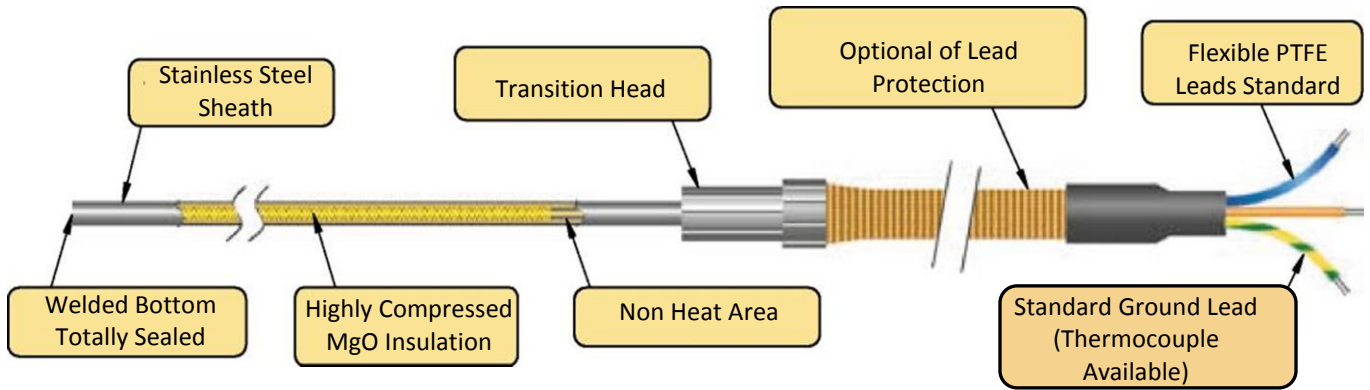

Optional Cross Sections

●	.07" (1.8mm)	●	.118" (3mm)	■	.118" x .118" (3mm x 3mm)
■	.06" x .09" (1.3 x 2.3mm)	■	.07" x .126" (1.8 x 3.2mm)	■	.086" x .165" (2.2 x 4.2mm)
■	.165" x .255" (4.2 x 6.5 mm)				

Lead Protection Options

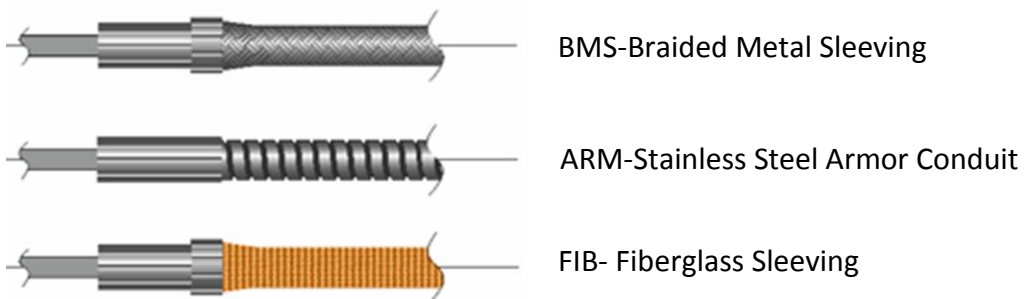

Exit Styles and Specifications

Standard Coil Exit Styles

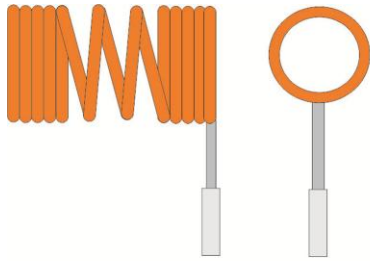

Exit Style 1

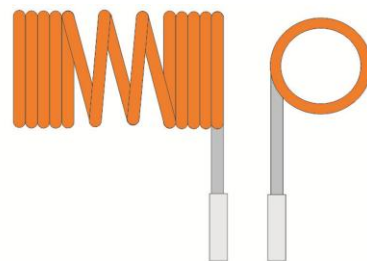

Exit Style 2

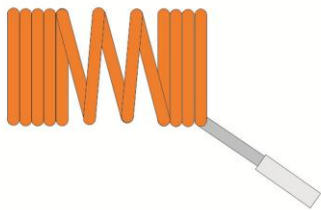

Exit Style 3
45 degree

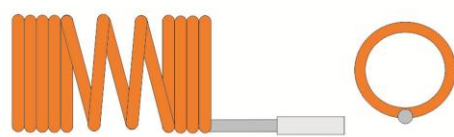

Exit Style 4

If you do not see your Exit Style, we can create a custom style to meet your requirements.

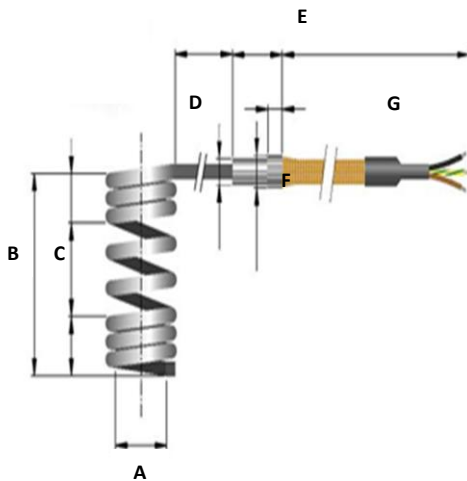

Coil Specification:

- A: Inside Diameter
- B: Coil Length
- C: Coil Spacing (length and number of coils)
- D: Exit Type
- E: Unheated Section Length
- F: Thermocouple
- G: Lead Protection

Stock Coil Heaters

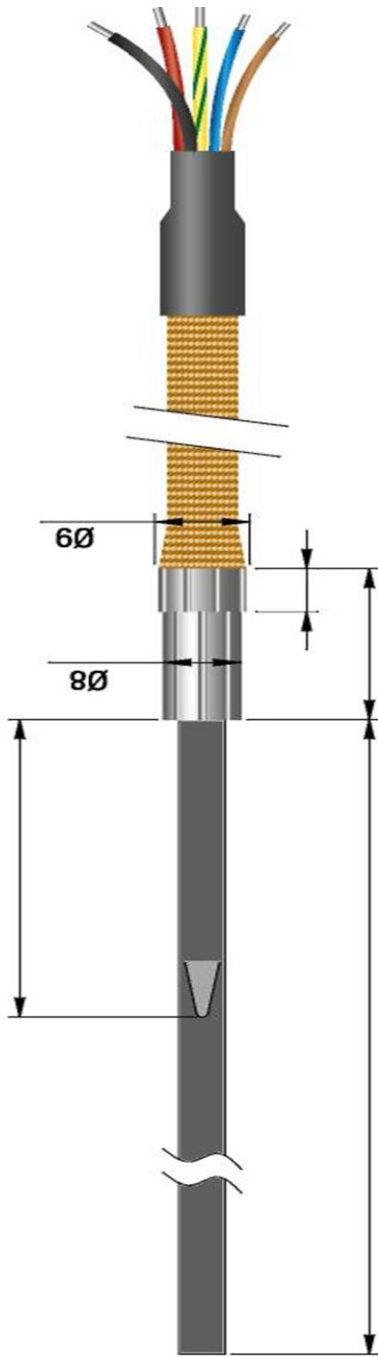

HTI PART #	WATTAGE @ 240V	HEATED LENGTH
HTS125A	125	9.84"
HTS175A	175	
HTS150B	150	11.81"
HTS225B	225	
HTS175C	175	13.77"
HTS250C	250	
HTS200D	200	15.75"
HTS300D	300	
HTS225E	225	17.72"
HTS350E	350	
HTS250F	250	19.68"
HTS400F	400	
HTS300G	300	23.62"
HTS450G	450	
HTS350H	350	27.56"
HTS500H	500	
HTS400J	400	31.50"
HTS600J	600	
HTS450K	450	35.43"
HTS700K	700	
HTS500L	500	39.37"
HTS800L	800	
HTS600M	600	47.25"
HTS900M	900	
HTS700N	700	55.12"
HTS1000N	1000	
HTS800P	800	63"
HTS800P	1100	
HTS900Q	900	70.87"
HTS1250Q	1250	
HTS1000R	1000	78.75"
HTS1400R	1400	

Maxi Replacement Heaters

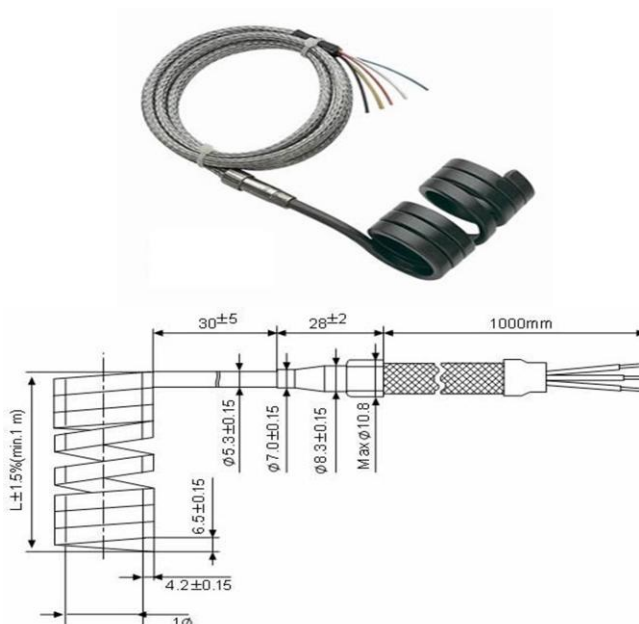

INSIDE DIAMETER		LENGTH													
MM	IN	2	40	60	80	100	120	140	160	180	200	220	240	260	280
20.0			400W	500W	650W	800W	900W	1000W	1100W	1200W	1300W	1400W	1500W	1600W	1700W
22.0	7/8'		400W	500W	650W	800W	900W	1000W	1100W	1200W	1300W	1400W	1500W	1600W	1700W
24.0			400W	500W	650W	800W	900W	1000W	1100W	1200W	1300W	1400W	1500W	1600W	1700W
25.0	1'		400W	600W	700W	850W	900W	1000W	1100W	1200W	1300W	1400W	1500W	1600W	1700W
28.0			450W	600W	750W	900W	1000W	1100W	1100W	1200W	1300W	1400W	1500W	1600W	1700W
30.0		300W	450W	700W	800W	900W	1000W	1100W	1100W	1200W	1300W	1400W	1500W	1600W	1700W
32.0	1 1/4'	300W	500W	700W	800W	1000W	1000W	1100W	1300W	1300W	1500W	1700W	1900W	2100W	2300W
35.0		300W	550W	800W	900W	1000W	1000W	1100W	1300W	1300W	1500W	1700W	1900W	2100W	2300W
38.0	1 1/2'	300W	600W	900W	900W	1200W	1300W	1300W	1600W	1600W	1800W	1800W	2000W	2200W	2400W
40.0		300W	650W	1000W	1000W	1200W	1300W	1300W	1600W	1600W	1800W	1800W	2000W	2200W	2400W
42.0		350W	650W	1000W	1100W	1300W	1500W	1500W	1600W	1600W	1800W	1800W	2000W	2200W	2400W
45.0		350W	700W	1000W	1100W	1500W	1500W	1500W	1600W	1600W	1800W	1800W	2000W	2200W	2400W
48.0		400W	750W	1000W	1200W	1500W	1500W	1700W	1700W	2000W	2200W	2400W	2600W	2800W	3000W
50.0	2'	400W	800W	1000W	1300W	1500W	1500W	1700W	1700W	2000W	2200W	2400W	2600W	2800W	3000W
55.0		400W	800W	1000W	1400W	1800W	2200W	2600W	3000W	3400W	3800W	4200W			
60.0		450W	800W	1000W	1400W	1800W	2200W	2600W	3000W	3400W	3800W	4200W			
65.0		500W	900W	1200W	1600W	2000W	2400W	2800W	3200W	3600W	4000W	4300W			
70.0		550W	900W	1200W	1600W	2000W	2400W	2800W	3200W	3600W	4000W	4300W			
75.0		550W	900W	1200W	1600W	2000W	2400W	2800W	3200W	3600W	4000W	4300W			
80.0		600W	1000W	1300W	1600W	2000W	2400W	2800W	3200W	3600W	4000W	4300W			
90.0		700W	1000W	1500W	2000W	2500W	2800W	3200W	3600W	4000W	4300W				
100.0		800W	1500W	1900W	2000W	2800W	3000W	3400W	3600W	4200W					

at 240v of voltage

Coil Heaters - Stock and Popular Sizes

.5" Internal Diameter

HTI PART #	WIDTH IN	WATTS	VOLTS	THERMOCOUPLE	PRICE
HTI5X1	1.5	175	240	YES	\$102.00
HTI5X2	1.5	200	240	YES	\$102.00
HTI5X3	1.5	250	240	YES	\$112.00
HTI5X4	2	300	240	YES	\$123.00
HTI5X5	2	345	240	YES	\$123.00
HTI5X6	2	345	120	YES	\$123.00
HTI5X7	2	350	240	YES	\$130.00
HTI5X8	2.5	300	240	YES	\$123.00
HTI5X9	2.5	350	240	YES	\$130.00
HTI5X10	2.5	400	240	YES	\$135.00
HTI5X11	3	400	240	YES	\$135.00
HTI5X12	3	450	240	YES	\$145.00
HTI5X13	3	500	240	YES	\$165.00
HTI5X14	3.5	450	240	YES	\$145.00
HTI5X15	3.5	500	240	YES	\$165.00
HTI5X16	3.5	600	240	YES	\$175.00
HTI5X17	3.5	700	240	YES	\$189.00
HTI5X18	4	550	240	YES	\$165.00
HTI5X19	4	600	240	YES	\$175.00
HTI5X20	4	700	240	YES	\$189.00
HTI5X21	4	800	240	YES	\$210.00
HTI5X22	4.5	300	240	YES	\$123.00
HTI5X23	4.5	300	120	YES	\$123.00
HTI5X24	4.5	500	240	YES	\$189.00
HTI5X25	4.5	550	240	YES	\$210.00
HTI5X26	4.5	650	240	YES	\$218.00
HTI5X27	4.5	800	240	YES	\$210.00
HTI5X28	4.5	900	240	YES	\$218.00
HTI5X29	4.5	1000	240	YES	\$225.00
HTI5X30	5	650	240	YES	\$218.00
HTI5X31	5	900	240	YES	\$218.00
HTI5X32	5	1000	240	YES	\$225.00
HTI5X33	5	1100	240	YES	\$235.00
HTI5X34	6	1100	240	YES	\$235.00
HTI5X35	6	1250	240	YES	\$245.00
HTI5X36	7	1000	240	YES	\$225.00
HTI5X37	7	1100	240	YES	\$235.00
HTI5X38	7	1250	240	YES	\$245.00
HTI5X40	7	1400	240	YES	\$225.00
HTI5X41	8	1000	240	YES	\$225.00
HTI5X42	8	1100	240	YES	\$235.00
HTI5X43	8	1250	240	YES	\$245.00
HTI5X44	8	1400	240	YES	\$255.00

Coil Heaters – Stock and Popular Sizes

.625" Internal Diameter

HTI PART#	WIDTH IN	WATTS	VOLTS	THERMOCOUPLE	PRICE
HTI625X1	1.5	175	240	YES	\$102.00
HTI625X2	1.5	200	240	YES	\$102.00
HTI625X3	1.5	250	240	YES	\$112.00
HTI625X4	1.5	300	240	YES	\$123.00
HTI625X5	1.5	350	240	YES	\$130.00
HTI625X6	2	225	240	YES	\$123.00
HTI625X7	2	250	240	YES	\$130.00
HTI625X8	2	300	240	YES	\$130.00
HTI625X9	2	350	240	YES	\$145.00
HTI625X10	2	400	240	YES	\$135.00
HTI625X11	2	450	240	YES	\$145.00
HTI625X12	2.5	250	240	YES	\$112.00
HTI625X13	2.5	300	240	YES	\$123.00
HTI625X14	2.5	350	240	YES	\$130.00
HTI625X15	2.5	400	240	YES	\$135.00
HTI625X16	2.5	450	240	YES	\$145.00
HTI625X17	3	400	240	YES	\$135.00
HTI625X18	3	450	240	YES	\$145.00
HTI625X19	3	500	240	YES	\$165.00
HTI625X20	3	700	240	YES	\$189.00
HTI625X21	3.5	400	240	YES	\$135.00
HTI625X22	3.5	450	240	YES	\$145.00
HTI625X23	3.5	500	240	YES	\$189.00
HTI625X24	3.5	550	240	YES	\$189.00
HTI625X25	3.5	700	240	YES	\$189.00
HTI625X26	3.5	800	240	YES	\$210.00
HTI625X27	3.5	900	240	YES	\$218.00
HTI625X28	4	550	240	YES	\$210.00
HTI625X29	4	700	240	YES	\$210.00
HTI625X30	4	800	240	YES	\$210.00
HTI625X31	4	900	240	YES	\$218.00
HTI625X32	4	1000	240	YES	\$225.00
HTI625X33	4.5	900	240	YES	\$218.00
HTI625X34	4.5	550	240	YES	\$210.00
HTI625X35	4.5	700	240	YES	\$210.00
HTI625X36	4.5	800	240	YES	\$218.00
HTI625X37	4.5	900	240	YES	\$218.00
HTI625X38	4.5	1000	240	YES	\$225.00
HTI625X40	5	900	240	YES	\$218.00
HTI625X41	5	550	240	YES	\$210.00
HTI625X42	5	700	240	YES	\$210.00
HTI625X43	5	800	240	YES	\$210.00
HTI625X44	5	900	240	YES	\$218.00
HTI625X45	5	1000	240	YES	\$225.00
HTI625X46	5	1100	240	YES	\$235.00
HTI625X47	6	1000	240	YES	\$225.00

Coil Heaters -Stock and Popular Sizes

.75" Internal Diameter

HTI PART#	WIDTH IN	WATTS	VOLTS	THERMOCOUPLE	PRICE
HTI750X1	1	200	240	YES	\$102.00
HTI750X2	1	250	240	YES	\$112.00
HTI750X3	1.5	175	240	YES	\$102.00
HTI750X4	1.5	200	240	YES	\$102.00
HTI750X5	1.5	250	240	YES	\$112.00
HTI750X6	1.5	300	240	YES	\$123.00
HTI750X7	1.5	350	240	YES	\$145.00
HTI750X8	2	225	240	YES	\$123.00
HTI750X9	2	250	240	YES	\$112.00
HTI750X10	2	300	240	YES	\$123.00
HTI750X11	2	350	240	YES	\$145.00
HTI750X12	2	400	240	YES	\$135.00
HTI750X13	2	450	240	YES	\$145.00
HTI750X14	2.5	250	240	YES	\$112.00
HTI750X15	2.5	300	240	YES	\$123.00
HTI750X16	2.5	350	240	YES	\$145.00
HTI750X17	2.5	400	240	YES	\$135.00
HTI750X18	2.5	450	240	YES	\$145.00
HTI750X19	3	400	240	YES	\$135.00
HTI750X20	3	450	240	YES	\$145.00
HTI750X21	3	500	240	YES	\$165.00
HTI750X22	3	550	240	YES	\$189.00
HTI750X23	3	700	240	YES	\$189.00
HTI750X24	3.5	400	240	YES	\$165.00
HTI750X25	3.5	450	240	YES	\$175.00
HTI750X26	3.5	500	240	YES	\$189.00
HTI750X27	3.5	550	240	YES	\$189.00
HTI750X28	3.5	700	240	YES	\$189.00
HTI750X29	3.5	800	240	YES	\$210.00
HTI750X30	3.5	900	240	YES	\$218.00
HTI750X31	4	550	240	YES	\$189.00
HTI750X32	4	700	240	YES	\$189.00
HTI750X33	4	800	240	YES	\$210.00
HTI750X34	4	900	240	YES	\$218.00
HTI750X35	4	1000	240	YES	\$225.00
HTI750X40	4.5	800	240	YES	\$210.00
HTI750X41	4.5	900	240	YES	\$218.00
HTI750X42	4.5	1000	240	YES	\$225.00
HTI750X43	5	900	240	YES	\$218.00
HTI750X44	5	550	240	YES	\$189.00
HTI750X45	5	700	240	YES	\$189.00
HTI750X46	5	800	240	YES	\$210.00
HTI750X47	5	900	240	YES	\$218.00

Coil Heaters - Stock and Popular Sizes

.875" Internal Diameter

HTI PART#	WIDTH IN	WATTS	VOLTS	THERMOCOUPLE	PRICE
HTI875X1	1	200	240	YES	\$102.00
HTI875X2	1	250	240	YES	\$112.00
HTI875X3	1	300	240	YES	\$102.00
HTI875X4	1.5	175	240	YES	\$102.00
HTI875X5	1.5	200	240	YES	\$102.00
HTI875X6	1.5	250	240	YES	\$112.00
HTI875X7	1.5	300	240	YES	\$123.00
HTI875X8	1.5	350	240	YES	\$145.00
HTI875X9	2	225	240	YES	\$123.00
HTI875X10	2	250	240	YES	\$112.00
HTI875X11	2	300	240	YES	\$123.00
HTI875X12	2	350	240	YES	\$145.00
HTI875X13	2	400	240	YES	\$135.00
HTI875X14	2	450	240	YES	\$145.00
HTI875X15	2.5	250	240	YES	\$112.00
HTI875X16	2.5	300	240	YES	\$123.00
HTI875X17	2.5	350	240	YES	\$145.00
HTI875X18	2.5	400	240	YES	\$135.00
HTI875X19	2.5	450	240	YES	\$145.00
HTI875X20	3	400	240	YES	\$135.00
HTI875X21	3	450	240	YES	\$145.00
HTI875X22	3	500	240	YES	\$165.00
HTI875X23	3	550	240	YES	\$189.00
HTI875X24	3	700	240	YES	\$189.00
HTI875X25	3.5	400	240	YES	\$165.00
HTI875X26	3.5	450	240	YES	\$175.00
HTI875X27	3.5	500	240	YES	\$189.00
HTI875X28	3.5	550	240	YES	\$189.00
HTI875X29	3.5	700	240	YES	\$189.00
HTI875X30	3.5	800	240	YES	\$210.00
HTI875X31	3.5	900	240	YES	\$218.00
HTI875X32	4	550	240	YES	\$189.00
HTI875X33	4	700	240	YES	\$189.00
HTI875X34	4	800	240	YES	\$210.00
HTI875X35	4	900	240	YES	\$218.00
HTI875X36	4	1000	240	YES	\$225.00
HTI875X38	4.5	550	240	YES	\$218.00
HTI875X42	4.5	900	240	YES	\$189.00
HTI875X43	4.5	1000	240	YES	\$189.00
HTI875X44	5	900	240	YES	\$218.00
HTI875X45	5	550	240	YES	\$218.00
HTI875X46	5	700	240	YES	\$225.00

Coil Heaters - Stock and Popular Sizes

1" Internal Diameter

HTI PART#	WIDTH IN	WATTS	VOLTS	THERMOCOUPLE	PRICE
HTI100X1	1	200	240	YES	\$102.00
HTI100X2	1	250	240	YES	\$112.00
HTI100X3	1	300	240	YES	\$123.00
HTI100X4	1	350	240	YES	\$135.00
HTI100X5	1.5	175	240	YES	\$102.00
HTI100X6	1.5	200	240	YES	\$102.00
HTI100X7	1.5	250	240	YES	\$112.00
HTI100X8	1.5	300	240	YES	\$123.00
HTI100X9	1.5	350	240	YES	\$145.00
HTI100X10	2	225	240	YES	\$123.00
HTI100X11	2	250	240	YES	\$112.00
HTI100X12	2	300	240	YES	\$123.00
HTI100X13	2	350	240	YES	\$145.00
HTI100X14	2	400	240	YES	\$135.00
HTI100X15	2	450	240	YES	\$145.00
HTI100X16	2.5	250	240	YES	\$112.00
HTI100X17	2.5	300	240	YES	\$123.00
HTI100X18	2.5	350	240	YES	\$145.00
HTI100X19	2.5	400	240	YES	\$135.00
HTI100X20	2.5	450	240	YES	\$145.00
HTI100X21	3	400	240	YES	\$135.00
HTI100X22	3	450	240	YES	\$145.00
HTI100X23	3	500	240	YES	\$165.00
HTI100X24	3	550	240	YES	\$189.00
HTI100X25	3	700	240	YES	\$189.00
HTI100X26	3.5	400	240	YES	\$165.00
HTI100X27	3.5	450	240	YES	\$175.00
HTI100X28	3.5	500	240	YES	\$189.00
HTI100X29	3.5	550	240	YES	\$189.00
HTI100X30	3.5	700	240	YES	\$189.00
HTI100X31	3.5	800	240	YES	\$210.00
HTI100X32	3.5	900	240	YES	\$218.00
HTI100X33	4	550	240	YES	\$189.00
HTI100X34	4	700	240	YES	\$189.00
HTI100X35	4	800	240	YES	\$210.00
HTI100X36	4	900	240	YES	\$218.00
HTI100X37	4	1000	240	YES	\$225.00
HTI100X38	4.5	900	240	YES	\$218.00
HTI100X40	4.5	550	240	YES	\$189.00
HTI100X41	4.5	700	240	YES	\$189.00
HTI100X42	4.5	800	240	YES	\$218.00
HTI100X43	4.5	900	240	YES	\$218.00
HTI100X44	4.5	1000	240	YES	\$225.00
HTI100X45	5	900	240	YES	\$218.00
HT100X48	5	800	240	YES	\$189.00

Coil Heaters - Stock and Popular Sizes

1.125" Internal Diameter

HTI PART #	WIDTH IN	WATTS	VOLTS	THERMOCOUPLE	PRICE
HTI1125X1	1	200	240	YES	\$102.00
HTI1125X2	1	250	240	YES	\$112.00
HTI1125X3	1	300	240	YES	\$123.00
HTI1125X4	1	350	240	YES	\$145.00
HTI1125X5	1.5	175	240	YES	\$102.00
HTI1125X6	1.5	200	240	YES	\$102.00
HTI1125X7	1.5	250	240	YES	\$112.00
HTI1125X8	1.5	300	240	YES	\$123.00
HTI1125X9	1.5	350	240	YES	\$145.00
HTI1125X10	2	225	240	YES	\$123.00
HTI1125X11	2	250	240	YES	\$112.00
HTI1125X12	2	300	240	YES	\$123.00
HTI1125X13	2	350	240	YES	\$145.00
HTI1125X14	2	400	240	YES	\$135.00
HTI1125X15	2	450	240	YES	\$145.00
HTI1125X16	2.5	250	240	YES	\$112.00
HTI1125X17	2.5	300	240	YES	\$123.00
HTI1125X18	2.5	350	240	YES	\$145.00
HTI1125X19	2.5	400	240	YES	\$135.00
HTI1125X20	2.5	450	240	YES	\$145.00
HTI1125X21	3	400	240	YES	\$135.00
HTI1125X22	3	450	240	YES	\$145.00
HTI1125X23	3	500	240	YES	\$165.00
HTI1125X24	3	550	240	YES	\$189.00
HTI1125X25	3	700	240	YES	\$189.00
HTI1125X26	3.5	400	240	YES	\$165.00
HTI1125X27	3.5	450	240	YES	\$175.00
HTI1125X28	3.5	500	240	YES	\$189.00
HTI1125X29	3.5	550	240	YES	\$189.00
HTI1125X30	3.5	700	240	YES	\$189.00
HTI1125X31	3.5	800	240	YES	\$210.00
HTI1125X32	3.5	900	240	YES	\$218.00
HTI1125X33	4	550	240	YES	\$189.00
HTI1125X34	4	700	240	YES	\$189.00
HTI1125X35	4	800	240	YES	\$210.00
HTI1125X36	4	900	240	YES	\$218.00
HTI1125X37	4	1000	240	YES	\$225.00
HTI1125X38	4.5	900	240	YES	\$218.00
HTI1125X40	4.5	550	240	YES	\$189.00
HTI1125X41	4.5	700	240	YES	\$189.00
HTI1125X42	4.5	800	240	YES	\$218.00
HTI1125X43	4.5	900	240	YES	\$218.00
HTI1125X44	4.5	1000	240	YES	\$225.00
HTI1125X45	5	800	240	YES	\$210.00
HTI1125X49	5	900	240	YES	\$218.00
HTI1125X50	5	1000	240	YES	\$225.00
HTI1125X51	5	1100	240	YES	\$268.00

Coil Heaters - Stock and Popular Sizes

1.25" Internal Diameter

HTI PART#	WIDTH IN	WATTS	VOLTS	THERMOCOUPLE	PRICE
HTI12X1A	1	200	240	YES	\$102.00
HTI12X2A	1	250	240	YES	\$112.00
HTI12X3A	1	300	240	YES	\$123.00
HTI12X4A	1	350	240	YES	\$145.00
HTI12X5A	1	400	240	YES	\$135.00
HTI12X6A	1.5	200	240	YES	\$102.00
HTI12X7A	1.5	250	240	YES	\$112.00
HTI12X8A	1.5	300	240	YES	\$123.00
HTI12X9A	1.5	350	240	YES	\$145.00
HTI12X10A	2	225	240	YES	\$123.00
HTI12X11A	2	250	240	YES	\$112.00
HTI12X12A	2	300	240	YES	\$123.00
HTI12X13A	2	350	240	YES	\$145.00
HTI12X14A	2	400	240	YES	\$135.00
HTI12X15A	2	450	240	YES	\$145.00
HTI12X16A	2.5	250	240	YES	\$112.00
HTI12X17A	2.5	300	240	YES	\$123.00
HTI12X18A	2.5	350	240	YES	\$145.00
HTI12X19A	2.5	400	240	YES	\$135.00
HTI12X20A	2.5	450	240	YES	\$145.00
HTI12X21A	3	400	240	YES	\$135.00
HTI12X22A	3	450	240	YES	\$145.00
HTI12X23A	3	500	240	YES	\$165.00
HTI12X24A	3	550	240	YES	\$189.00
HTI12X25A	3	700	240	YES	\$189.00
HTI12X26A	3.5	400	240	YES	\$165.00
HTI12X27A	3.5	450	240	YES	\$175.00
HTI12X28A	3.5	500	240	YES	\$189.00
HTI12X29A	3.5	550	240	YES	\$189.00
HTI12X30A	3.5	700	240	YES	\$189.00
HTI12X31A	3.5	800	240	YES	\$210.00
HTI12X32A	3.5	900	240	YES	\$218.00
HTI12X33A	4	550	240	YES	\$189.00
HTI12X341A	4	700	240	YES	\$189.00
HTI12X35A	4	800	240	YES	\$210.00
HTI12X36A	4	900	240	YES	\$218.00
HTI12X37A	4	1000	240	YES	\$225.00
HTI12X38A	4.5	900	240	YES	\$218.00
HTI12X39A	4.5	550	240	YES	\$189.00
HTI12X40A	4.5	700	240	YES	\$189.00
HTI12X41A	4.5	800	240	YES	\$210.00
HTI12X42A	4.5	900	240	YES	\$218.00
HTI12X43A	4.5	1000	240	YES	\$225.00
HTI12X47A	5	800	240	YES	\$210.00
HTI12X48A	5	900	240	YES	\$218.00
HTI12X49A	5	1000	240	YES	\$225.00
HTI12X50A	5	1100	240	YES	\$268.00

Coil Heaters – Stock and Popular Sizes

1.375" Internal Diameter

HTI PART #	WIDTH IN	WATTS	VOLTS	THERMOCOUPLE	PRICE
HTI135X1A	1	200	240	YES	\$102.00
HTI135X2A	1	250	240	YES	\$112.00
HTI135X3A	1	300	240	YES	\$123.00
HTI135X4A	1	350	240	YES	\$135.00
HTI135X5A	1	400	240	YES	\$135.00
HTI135X6A	1.5	200	240	YES	\$102.00
HTI135X7A	1.5	250	240	YES	\$112.00
HTI135X8A	1.5	300	240	YES	\$123.00
HTI135X9A	1.5	350	240	YES	\$145.00
HTI135X10A	2	225	240	YES	\$123.00
HTI135X11A	2	250	240	YES	\$112.00
HTI135X12A	2	300	240	YES	\$123.00
HTI135X13A	2	350	240	YES	\$145.00
HTI135X14A	2	400	240	YES	\$135.00
HTI135X15A	2	450	240	YES	\$145.00
HTI135X16A	2.5	250	240	YES	\$112.00
HTI135X17A	2.5	300	240	YES	\$123.00
HTI135X18A	2.5	350	240	YES	\$145.00
HTI135X19A	2.5	400	240	YES	\$135.00
HTI135X20A	2.5	450	240	YES	\$145.00
HTI135X21A	3	400	240	YES	\$135.00
HTI135X22A	3	450	240	YES	\$145.00
HTI135X23A	3	500	240	YES	\$165.00
HTI135X24A	3	550	240	YES	\$189.00
HTI135X25A	3	700	240	YES	\$189.00
HTI135X26A	3.5	400	240	YES	\$165.00
HTI135X27A	3.5	450	240	YES	\$175.00
HTI135X28A	3.5	500	240	YES	\$189.00
HTI135X29A	3.5	550	240	YES	\$189.00
HTI135X30A	3.5	700	240	YES	\$189.00
HTI135X31A	3.5	800	240	YES	\$210.00
HTI135X32A	3.5	900	240	YES	\$218.00
HTI135X33A	4	550	240	YES	\$189.00
HTI135X34A	4	700	240	YES	\$189.00
HTI135X35A	4	800	240	YES	\$210.00
HTI135X36A	4	900	240	YES	\$218.00
HTI135X37A	4	1000	240	YES	\$225.00
HTI135X38A	4.5	900	240	YES	\$218.00
HTI135X39A	4.5	550	240	YES	\$189.00
HTI135X40A	4.5	700	240	YES	\$189.00
HTI135X41A	4.5	800	240	YES	\$210.00
HTI135X42A	4.5	900	240	YES	\$218.00
HTI135X43A	4.5	1000	240	YES	\$225.00
HTI135X48A	5	900	240	YES	\$218.00
HTI135X49A	5	1000	240	YES	\$225.00
HTI135X50A	5	1100	240	YES	\$268.00

Coil Heaters - Stock and Popular Sizes

1.5" Internal Diameter

HTI PART #	WIDTH IN	WATTS	VOLTS	THERMOCOUPLE	PRICE
HTIX1A	1	200	240	YES	\$102.00
HTIX2A	1	250	240	YES	\$112.00
HTIX3A	1	300	240	YES	\$123.00
HTIX4A	1	350	240	YES	\$135.00
HTIX5A	1	400	240	YES	\$135.00
HTIX6A	1.5	200	240	YES	\$102.00
HTIX7A	1.5	250	240	YES	\$112.00
HTIX8A	1.5	300	240	YES	\$123.00
HTIX9A	1.5	350	240	YES	\$145.00
HTIX10A	2	225	240	YES	\$123.00
HTIX11A	2	250	240	YES	\$112.00
HTIX12A	2	300	240	YES	\$123.00
HTIX13A	2	350	240	YES	\$145.00
HTIX14A	2	400	240	YES	\$135.00
HTIX15A	2	450	240	YES	\$145.00
HTIX16A	2.5	250	240	YES	\$112.00
HTIX17A	2.5	300	240	YES	\$123.00
HTIX18A	2.5	350	240	YES	\$145.00
HTIX19A	2.5	400	240	YES	\$135.00
HTIX20A	2.5	450	240	YES	\$145.00
HTIX21A	3	400	240	YES	\$135.00
HTIX22A	3	450	240	YES	\$145.00
HTIX23A	3	500	240	YES	\$165.00
HTIX24A	3	550	240	YES	\$189.00
HTIX25A	3	700	240	YES	\$189.00
HTIX26A	3.5	400	240	YES	\$165.00
HTIX27A	3.5	450	240	YES	\$175.00
HTIX28A	3.5	500	240	YES	\$189.00
HTIX29A	3.5	550	240	YES	\$189.00
HTIX30A	3.5	700	240	YES	\$189.00
HTIX31A	3.5	800	240	YES	\$210.00
HTIX32A	3.5	900	240	YES	\$218.00
HTIX33A	4	550	240	YES	\$189.00
HTIX341A	4	700	240	YES	\$189.00
HTIX35A	4	800	240	YES	\$210.00
HTIX36A	4	900	240	YES	\$218.00
HTIX37A	4	1000	240	YES	\$225.00
HTIX38A	4.5	900	240	YES	\$218.00
HTIX39A	4.5	550	240	YES	\$189.00
HTIX40A	4.5	700	240	YES	\$189.00
HTIX41A	4.5	800	240	YES	\$210.00
HTIX42A	4.5	900	240	YES	\$218.00
HTIX43A	4.5	1000	240	YES	\$225.00
HTIX44A	5	900	240	YES	\$218.00
HTIX45A	5	1000	240	YES	\$225.00
HTIX46A	5	1100	240	YES	\$268.00

High-Temp Industries

Other Quality Products



Cartridge Heaters



Split Sheath Heaters



Cast in Coil Heaters



Platinum Heaters



Nozzle Heaters



Cast Heaters



Tubular Heaters



Ceramic Band Heaters



PID Controllers



Thermocouples



Hot Runner Cables



Hot Runner Controllers

And more.....www.high-temp.com