

High-Temp Industries

Superior Quality
Comprehensive Services
Unequaled Value

Hot Runner Controllers and Accessories
2012

Phone 215-794-0864
Fax 215-794-7583
www.high-temp.com

Table of Contents

Hot Runner Controllers	3
Hot Runner Controller Mainframes	4
Single, Dual and Three Zone Mainframes	4
30 Amp Mainframes	5
SINGLE ZONE	6
8 ZONE DUAL DOW/DUAL DOW	6
12 ZONE SINGLE DOW/DUAL DOW	6
8 ZONE DUAL DOW/DUAL DOW	7
12 ZONE DUAL DOW/DUAL DOW	7
16 ZONE DUAL DOW/DUAL DOW	7
24 ZONE SINGLE DOW/SINGLE DOW	7
30 AMP 3 ZONE	8
30 AMP 6 ZONE	8
DME Replacement Cables	9
Hot Runner Connector Kits	10
HBE Connectors	11
EE Connectors	12
HA Connectors	13
HBS High Amperage Connectors	14
HD Connectors	15
Bases and Hoods	16

Hot Runner Controllers



Price: \$145.00 each

12 or more: \$135.00 each

High-Temp Industries provides exceptional quality and reliability to the plastics industry with our HTI-20 Hot Runner Controller Series. Designed to withstand the most adverse working environments with ease, these units provide years of use with little or no maintenance. Engineered to be both informative and easy to use, the HTI-20 has the ability to read PT100 RTDs and thus be used by multiple markets. Switching from calibrations of all popular thermocouples types, including J, K, T, and E is accomplished via a simple selection change within the programming, while intelligent PID with phase angle power output increases heater life and provides highly-accurate temperature control for even the most demanding of applications.

Features:

- Accurate control +/- 1°F (0.5°C) over the full temperature range.
- Self-diagnostics.
- Phase Angle Power output increasing heater life.
- Auto Soft Start (programmable and adjustable to meet individual material requirements).
- Manual mode selectable without shutting down of controller.
- Dehumidify mode (to remove moisture within the heaters prior to soft start further increasing the life of the heating elements).
- Dual voltage can be run on either 120v or 240v with no changes.
- Multiple inputs, Type J, K, E, T and others selectable via control buttons.
- Either grounded or ungrounded thermocouple junctions.
- Pt100 input with only a internal jumper added.
- Audible alarm.
- Over current protection.
- Over temperature alarm.
- Shorted TRIAC/Heater protection.
- Input power fuse protection.
- Selectable degrees C or F.
- Thermocouple break indicator.
- Thermocouple wire reverse indicator.
- RS-485 communication allows remote access and control.
- Two year warranty.

Hot Runner Controller Mainframes



High-Temp Industries hot runner controller mainframes are designed and built to withstand the most adverse working environments for years of reliable service and little or no maintenance. Manufactured of high strength aircraft grade aluminum, these units are extremely durable against physical damage. Completely interchangeable with other manufactures' hot runner control modules and mainframes including Athena, ITC, MCS and others - just insert the cards and operate the same as with other mainframes. Available in standard configurations of up to 48 zones at 15 amps per zone and up to 6 zones for 30 amp systems, we can meet your specific configuration.

Single, Dual and Three Zone Mainframes

High-Temp Industries offers a complete line of Hot Runner Controller Mainframes. We can provide you with a Mainframe designed to meet your individual requirements while providing you with the best quality products available at a fair price. High-Temp Industries offer standard hot runner single, dual and three zone controllers for plastic processes

Single-Zone Mainframe: \$150.00

Dual-Zone Mainframe: \$310.00

Three-Zone Mainframe: \$395.00

Hot Runner Controller Mainframes

The 5, 8 and 12 zone frames use individual frame sections, while the 16 thru 48 zone frames use 2, 3 or 4 frame sections fastened together into one prewired integral unit that requires only one main AC power input connection.

HTI PART #	NUMBER OF ZONES	PRICE
HTIMF05	5	\$600.00
HTIMF08	8	\$700.00
HTIMF12	12	\$800.00
HTIMF16	16	\$1,300.00
HTIMF20	20	\$1,400.00
HTIMF24	24	\$1,500.00
HTIMF28	28	\$2,100.00
HTIMF32	32	\$2,200.00
HTIMF36	36	\$2,400.00
HTIMF40	40	\$3,000.00
HTIMF44	44	\$3,100.00
HTIMF48	48	\$3,200.00

30 Amp Mainframes

The four configurations illustrated below provide 2, 3, 5, or 6 zones of 30 Amp control for higher wattage heater applications

HTI PART #	NUMBER OF ZONES	PRICE
HTIMFH2	2	\$1,000.00
HTIMFH3	3	\$1,100.00
HTIMFH5	5	\$1,400.00
HTIMFH6	6	\$1,500.00

Combinations frames to accommodate both 15 and 30 Amp modules are available by special request

Hot Runner Cables

High-Temp Industries' Hot Runner Cables are designed and manufactured for ease of use and simple repair without having to shorten the cable. Made with robotic grade industrial poly conduit and individually-stranded 16-gauge wire, our Cables are designed for years of use over conventional hot runner cables. High-Temp Industries Cables are assembled using the highest quality components on the market, we utilize machine pins not crimp pins as other companies do. Pins will simply never push out.

SINGLE ZONE

4-Pin HA plus ground	10-Foot	15-Foot	20-Foot	
		(Standard)		
Combination Power/ Thermocouple Cables	HTI-4HA-10	HTI-4HA-15	HTI-4HA-20	
Price	\$99.00	\$115.00	\$125.00	

8 ZONE SINGLE DOW/DUAL DOW

16-Pin HBE SINGLE DOW	10-Foot	15-Foot	20-Foot	
		(Standard)		
Power Cable (Black Conduit)	HT-16H-10	HT-16H-15	HT-16H-20	
Price	\$130.00	\$154.00	\$179.00	
Thermocouple Cable (Gray Conduit)	HTFC-16H-10	HTFC-16H-15	HTFC-16H-20	
Price	\$130.00	\$154.00	\$179.00	

12 ZONE SINGLE DOW/DUAL DOW

24-Pin HBE SINGLE DOW	10-Foot	15-Foot	20-Foot	
		(Standard)		
Power Cable (Black Conduit)	HT24H-10	HT-24H-15	HT-24H-20	
Price	\$149.00	\$170.00	\$240.00	
Thermocouple Cable (Gray Conduit)	HTFC-24H-10	HTFC-24H-15	HTFC-24H-20	
Price	\$149.00	\$170.00	\$240.00	

8 ZONE DUAL DOW/DUAL DOW

16-Pin HBE DUAL DOW	10-Foot	15-Foot	20-Foot
		(Standard)	
Power Cable (Black Conduit)	HTD-16H-10	HTD-16H-15	HTD-16H-20
Price	\$155.00	\$185.00	\$210.00
Thermocouple Cable (Gray Conduit)	HTF-16H-10	HTF-16H-15	HTF-16H-20
Price	\$155.00	\$185.00	\$210.00



12 ZONE DUAL DOW/DUAL DOW

24-Pin HBE DUAL DOW	10-Foot	15-Foot	20-Foot
		(Standard)	
Power Cables (Black Conduit)	HTD-24H-10	HTD-24H-15	HTD-24H-20
Price	\$169.00	\$190.00	\$260.00
Thermocouple Cables (Gray Conduit)	HDD-24H-10	HDD-24H-15	HDD-24H-20
Price	\$169.00	\$190.00	\$260.00



16 ZONE DUAL DOW/DUAL DOW

32-Pin HBE	10-Foot	15-Foot	20-Foot
		(Standard)	
Power Cables (Black Conduit)	HTD-32H-10	HTD-32H-15	HTD-32H-20
Price	\$212.00	\$238.00	\$290.00
Thermocouple Cables (Gray Conduit)	HDD-32H-10	HDD-32H-15	HDD-32H-20
Price	\$212.00	\$238.00	\$290.00



24 ZONE SINGLE DOW/SINGLE DOW

48-Pin HBE	10-Foot	15-Foot	20-Foot
		(Standard)	
Power Cables (Black Conduit)	HTD-48H-10	HTD-48H-15	HTD-48H-20
Price	\$255.00	\$285.00	\$315.00
Thermocouple Cables (Gray Conduit)	HDD-48H-10	HDD-48H-15	HDD-48H-20
Price	\$255.00	\$285.00	\$315.00



30 AMP 3 ZONE

6-Pin HBS	10-Foot	20-Foot	30-Foot	
Power Cables		(Standard)		
3-Zones High-AMP	HHP-30A-10	HHP-30A-20	HHP-30A-30	
Price	\$257.00	\$282.00	\$317.00	

30 AMP 6 ZONE

12-Pin HBS	10-Foot	20-Foot	30-Foot	
Power Cables		(Standard)		
6-Zones High-AMP	HP-30A2-10	HP-30A2-20	HP-30A2-30	
Price	\$405.00	\$458.00	\$495.00	

DME Replacement Cables

ZONES	10-Foot	20-Foot	30-Foot
Power Cable (Black Conduit)		(Standard)	
12-Zones	MPC12C10	MPC12C20	MPC12C30
Price	\$149.00	\$188.00	\$238.00
8-Zones	MPC08C10	MPC08C20	MPC08C30
Price	\$130.00	\$161.00	\$194.00
5-Zones	MPC05C10	MPC05C20	MPC05C30
Price	\$109.00	\$139.00	\$169.00



ZONES	10-Foot	20-Foot	30-Foot
Thermocouple Cable(Gray Conduit)		(Standard)	
12-Zones	TC12C10	TC12C20	TC12C30
Price	\$150.00	\$189.00	\$240.00
8-Zones	TC08C10	TC08C20	TC08C30
Price	\$118.50	\$147.00	\$172.00
5-Zones	TC05C10	TC05C20	TC05C30
Price	\$103.00	\$132.00	\$159.00







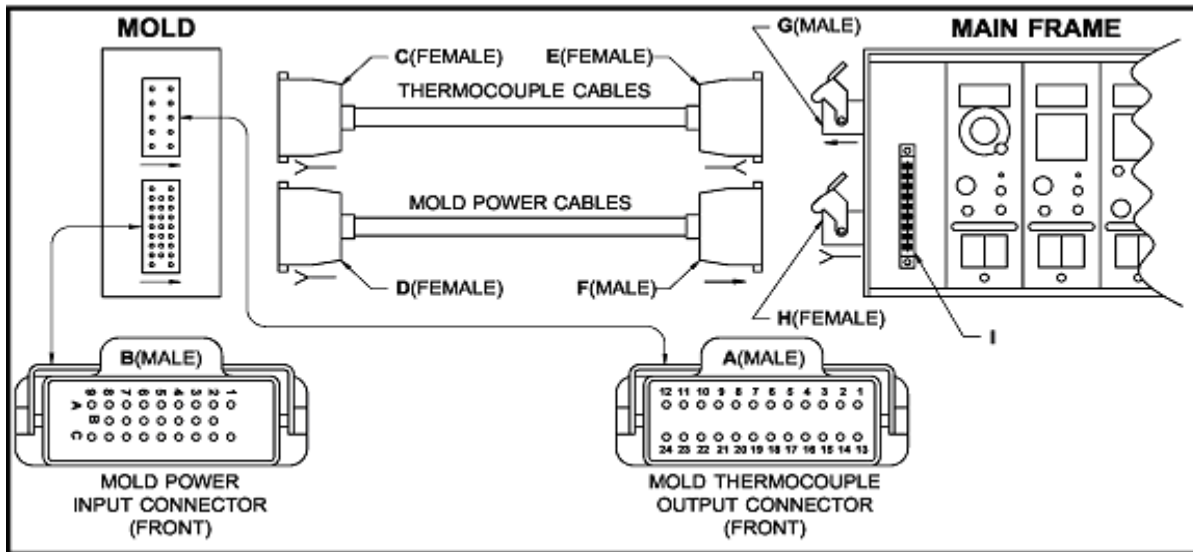

Don't see your length?
We can build to your requirements!

Hot Runner Connector Kits







REF.	DESCRIPTION	HTI PART #	PRICE
	Mold Thermocouple Output Connector 5-Zone, and all 30 Amp	MTC5	\$46.50
A	Mold Thermocouple Output Connector 8-Zone	MTC8	\$55.00
	Mold Thermocouple Output Connector 12-Zone	MTC12	\$70.00
	Mold Power Input Connector 5-Zone	PIC5	\$32.60
	Mold Power Input Connector 8-Zone	PIC8	\$36.00
	Mold Power Input Connector 12-Zone	PIC12	\$44.60
B	Mold Power Input Connector for 2-3 Zone 30 Amp	PICH23	\$75.20
	Mold Power Input Connector for 5-Zone 30 Amp	PICH5	\$169.1
	Mold Power Input Connector For 6-Zone 30 Amp	PICH6	\$178.5
	Mold End Kit for all Thermocouple Cable 5-Zone (10,15, or 30 Amp)	CKTF15	\$55.70
C	Mold End Kit for all Thermocouple Cable 8-Zone (10,15, or 30 Amp)	CKTF18	\$72.90
	Mold End Kit for all Thermocouple Cable 12-Zone (10,15, or 30 Amp)	CKTF112	\$103.0
	Mold End Kit for all 10 or 15 amp Power Cables	CKPF112B	\$42.90
D	Mold End Kit for 2 or 3 Zone, 30 Amp Power Cables	CKPF13C	\$57.20
	Mold End Kit for 5-Zone, 30 Amp Power Cables	CKPF15C	\$145.1
E	Frame End Kit for all Thermocouple Cables (10,15, or 30 Amp)	CKTF112A	\$42.90
	Frame End Kit for all 10 or 15 Amp Power Cables	CKPM112B	\$42.90
F	Frame End Kit for 2 or 3 Zone, 30 Amp Power Cables	CKPM13C	\$57.20
	Frame End Kit for 5-Zone, 30 Amp Power Cables	CKPM15C	\$150.0
G	Thermocouple Input Kit for all Main Frames (10, 15, or 30 Amp)	CKTM212A	\$35.20
	Power Output Kit for all 10 or 15 Amp Main Frames	CKPF212B	\$35.15
H	Power Output Kit for 2 or 3 Zone, 30 Amp Main Frames	CKPF23C	\$57.20
	Power Output Kit for 5-Zone, 30 Amp Main Frames	CKPF25C	\$92.35
	PC Board Edge Connector Housing for all Main Frames and Modules	CBF2	\$11.90
I	PC Board Edge Connectors for CBF2 (connector pins)	CBF3	\$1.05

HBE Connectors







<p>6 HBE Male</p>		<p>6 HBE Female</p>	
<p>10 HBE Male</p>		<p>10 HBE Female</p>	
<p>16 HBE Male</p>		<p>16 HBE Female</p>	
<p>24 HBE Male</p>		<p>24 HBE Female</p>	

EE Connectors



Available with Iron and Constantan Pins

<p>32 EE Male</p>		<p>32 EE Female</p>	
<p>46 EE Male</p>		<p>46 EE Female</p>	

HA Connectors



4 HA Male		4 HA Female	
10 HA Male		10 HA Female	
32 HA Male and Female		48 HA Female	

HBS High Amperage Connectors

<p>6 HBS Male</p>	 A rectangular, light gray metal connector with six circular contact points arranged in two rows of three. It has a locking mechanism on the right side.	<p>6 HBS Female</p>	 A rectangular, light gray metal connector with six rectangular contact points arranged in two rows of three. It has a locking mechanism on the right side.
-----------------------	-------------------------------------------------------------------------------------------------------------------------------------------------------------------------------------------------------------------------------------------	-------------------------	------------------------------------------------------------------------------------------------------------------------------------------------------------------------------------------------------------------------------------------------

HD Connectors

25 HD Male		25 HD Female	
---------------	-----------------------------------------------------------------------------------	-----------------	-------------------------------------------------------------------------------------

40 HD Male		40 HD Female	
---------------	-----------------------------------------------------------------------------------	-----------------	-------------------------------------------------------------------------------------

64 HD Male		64 HD Female	
---------------	-------------------------------------------------------------------------------------	-----------------	---------------------------------------------------------------------------------------

Bases and Hoods

<p>Single Latch Base and Hood</p>	 <p>The image shows two components: a metal latch frame with a black handle at the top, and a grey rectangular base with a black lens on top.</p>
<p>Double Latch Base and Hood</p>	 <p>The image shows two components: a metal latch frame with two black handles, and a grey rectangular base with a black lens on top.</p>
<p>Double Latch Side Entry Hood</p>	 <p>The image shows a grey rectangular hood with a black lens on the top right side and two black handles on the front.</p>
<p>Single Latch Top Entry Hood with 90 degree Fitting</p>	 <p>The image shows a grey rectangular hood with a black lens on top, a black handle on the front, and a 90-degree fitting on the side.</p>
<p>Cable Coupler Double Latch Hood</p>	 <p>The image shows a grey rectangular hood with two black handles on the front and a cable coupler on top.</p>

High-Temp Industries

Other Quality Products



Cartridge Heaters



Split Sheath Heaters



Cast in Coil Heaters



Platinum Heaters



Nozzle Heaters



Cast Heaters



Tubular Heaters



Ceramic Band Heaters



PID Controllers



Thermocouples



Hot Runner Cables



Hot Runner Controllers

And more.....www.high-temp.com