

# High-Temp Industries

Superior Quality  
Comprehensive Services  
Unequaled Value

## Split Sheath Cartridge Heaters 2012

Phone 215-794-0864

Fax 215-794-7583

[www.high-temp.com](http://www.high-temp.com)

## Table of Contents

Split Sheath Cartridge Heaters.....	3
Split Sheath Cartridge Heater Advantages .....	4
Technical Specifications .....	5
Available Heater Sizes .....	5
Stock .25”Diameter Heaters .....	6
.25” Diameter Options Selection .....	8
Stock .375” Diameter Heaters .....	13
.375” Diameter Options Selection .....	18
Stock .5” Diameter Heaters .....	22
.5” Diameter Options Selection .....	27
Stock .625” Diameter Heaters .....	31
.625” Diameter Options Selection Page .....	35
Stock .75” Diameter Heaters .....	38
.75” Diameter Options Selection .....	41
Stock 1” Diameter Heaters .....	45
1” Diameter Options Selection .....	46

# Split Sheath Cartridge Heaters



High-Temp Industries' split sheath cartridge heaters are designed to provide superior conductive heat transfer and easy change-out. Our split sheath cartridge heaters provide even sheath temperatures up to 1600°F and resolve the common problem of stuck heaters. Uneven temperatures can cause the passages inside of platens and dies to curve, making it difficult to remove the heater. Our split sheath cartridge heaters are essentially tubular elements formed into a "D" shape. They are then bent back forming two independent heated legs allowing for bilateral movement of each leg separate from the other. This independent movement allows for our heaters to "fill" existing bore holes even if they have been subject to excessive wear or damage. When energized, the sections expand and improve surface contact with platens, dies, and molds; when cool, the sections contract back to original diameter for easy removal.

High-Temp Industries split sheath cartridge heaters are available in diameters ranging from .25" inches to 1" and 6mm to 25.4mm metric. Sheath lengths are available from 2 to 120 inches. Available in voltages from 12v to 480v and watt densities up to 250w<sup>2</sup> maintaining a 1 year warranty against manufacture defects. We also offer a wide assortment of terminations and lead material to meet your application demands. An optional thermocouple groove can also be added increasing the flexibility to meet your individual requirements. High-Temp Industries split sheath cartridge heaters can be fitted with any of the same termination and wire options as standard cartridge heaters. Please allow us the opportunity to meet your requirements and custom design a solution to your heating needs.

# Split Sheath Cartridge Heater Advantages

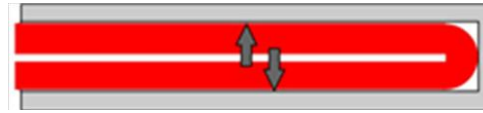

The split sheath design allows for each independent leg to bilaterally expand into existing bore holes and compensates for oversize bore holes.



Conventional cartridge heater limited in its ability to expand into bore holes.

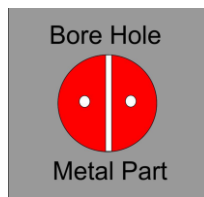

Split sheath cartridge heater energized expands into bore hole providing superior metal to metal contact.



Split sheath cartridge heater de-energized allowing easy removal.

## Technical Specifications

<b>Watt Density</b>	<b>Warranty up to 250W<sup>2</sup></b>
<b>Voltage</b>	<b>Dependent Upon Diameter</b>
<b>Hipot</b>	<b>&lt;=0.1mA a 240 v.</b>
<b>M Ohms</b>	<b>&gt;5 mOhms @ 500 Watts minimum</b>
<b>Dielectric Strength</b>	<b>1500v. 1/seg</b>
<b>Working Temperature</b>	<b>1600°F</b>
<b>Tolerance of Length</b>	<b>+/-1.5%</b>
<b>Tolerance of Diameter</b>	<b>.002"-.004"</b>
<b>Lead Wire Tolerance</b>	<b>+/-1/2"</b>
<b>Power Tolerance (w)</b>	<b>+ 5 % - 10 %</b>
<b>Cold Areas</b>	<b>Dependent Upon Diameter</b>

## Available Heater Sizes

<b>Imperial</b>	<b>1/4"</b>	<b>5/16"</b>	<b>3/8"</b>	<b>1/2"</b>	<b>5/8"</b>	<b>3/4"</b>	<b>1.00"</b>
<b>Metric</b>	<b>4mm</b>	<b>5mm</b>	<b>6mm</b>	<b>6.5mm</b>	<b>7mm</b>	<b>8mm</b>	<b>10mm</b>
	<b>12mm</b>	<b>14mm</b>	<b>16mm</b>	<b>18mm</b>	<b>20mm</b>	<b>22mm</b>	<b>25mm</b>

## Stock .25" Diameter Heaters

LENGTH	VOLTS	WATTS	14" LEADS	PRICE	26" LEADS	PRICE	38" LEADS	PRICE
1	120	55	HTSS25010A-14S	\$28.92	HTSS25010A-26S	\$34.64	HTSS25010A-38S	\$40.35
1	120	100	HTSS25010B-14S	\$28.92	HTSS25010B-26S	\$34.64	HTSS25010B-38S	\$40.35
1	240	100	HTSS25010C-14S	\$28.92	HTSS25010C-26S	\$34.64	HTSS25010C-38S	\$40.35
1.25	120	75	HTSS25012A-14S	\$28.92	HTSS25012A-26S	\$34.64	HTSS25012A-38S	\$40.35
1.5	120	50	HTSS25015B-14S	\$31.44	HTSS25015B-26S	\$37.16	HTSS25015B-38S	\$42.87
1.5	120	100	HTSS25015C-14S	\$31.44	HTSS25015C-26S	\$37.16	HTSS25015C-38S	\$42.87
1.5	120	150	HTSS25015D-14S	\$31.44	HTSS25015D-26S	\$37.16	HTSS25015D-38S	\$42.87
1.5	240	150	HTSS25015E-14S	\$31.44	HTSS25015E-26S	\$37.16	HTSS25015E-38S	\$42.87
1.5	120	200	HTSS25015F-14S	\$31.44	HTSS25015F-26S	\$37.16	HTSS25015F-38S	\$42.87
1.5	240	200	HTSS25015B-14S	\$31.44	HTSS25015B-26S	\$37.16	HTSS25015B-38S	\$42.87
2	120	50	HTSS25020A-14S	\$35.85	HTSS25020A-26S	\$41.57	HTSS25020A-38S	\$47.28
2	120	100	HTSS25020B-14S	\$35.85	HTSS25020B-26S	\$41.57	HTSS25020B-38S	\$47.28
2	120	150	HTSS25020C-14S	\$35.85	HTSS25020C-26S	\$41.57	HTSS25020C-38S	\$47.28
2	240	150	HTSS25020D-14S	\$35.85	HTSS25020D-26S	\$41.57	HTSS25020D-38S	\$47.28
2	120	200	HTSS25020E-14S	\$35.85	HTSS25020E-26S	\$41.57	HTSS25020E-38S	\$47.28
2	240	200	HTSS25020A-14S	\$35.85	HTSS25020A-26S	\$41.57	HTSS25020A-38S	\$47.28
2	120	250	HTSS25020G-14S	\$35.85	HTSS25020G-26S	\$41.57	HTSS25020G-38S	\$47.28
2	240	250	HTSS25020H-14S	\$35.85	HTSS25020H-26S	\$41.57	HTSS25020H-38S	\$47.28
2.5	120	200	HTSS25025A-14S	\$35.85	HTSS25025A-26S	\$41.57	HTSS25025A-38S	\$47.28
2.5	240	200	HTSS25025B-14S	\$35.85	HTSS25025B-26S	\$41.57	HTSS25025B-38S	\$47.28
3	120	75	HTSS25030A-14S	\$40.26	HTSS25030A-26S	\$45.98	HTSS25030A-38S	\$51.69
3	120	150	HTSS25030B-14S	\$40.26	HTSS25030B-26S	\$45.98	HTSS25030B-38S	\$51.69
3	120	200	HTSS25030C-14S	\$40.26	HTSS25030C-26S	\$45.98	HTSS25030C-38S	\$51.69
3	240	200	HTSS25030D-14S	\$40.26	HTSS25030D-26S	\$45.98	HTSS25030D-38S	\$51.69
3	120	300	HTSS25030E-14S	\$40.26	HTSS25030E-26S	\$45.98	HTSS25030E-38S	\$51.69
3	240	300	HTSS25030A-14S	\$40.26	HTSS25030A-26S	\$45.98	HTSS25030A-38S	\$51.69
4	120	100	HTSS25040A-14S	\$44.67	HTSS25040A-26S	\$50.39	HTSS25040A-38S	\$56.10
4	120	200	HTSS25040B-14S	\$44.67	HTSS25040B-26S	\$50.39	HTSS25040B-38S	\$56.10
4	240	200	HTSS25040C-14S	\$44.67	HTSS25040C-26S	\$50.39	HTSS25040C-38S	\$56.10
4	120	300	HTSS25040D-14S	\$44.67	HTSS25040D-26S	\$50.39	HTSS25040D-38S	\$56.10
4	240	300	HTSS25040E-14S	\$44.67	HTSS25040E-26S	\$50.39	HTSS25040E-38S	\$56.10

## Stock .25" Diameter Heaters (Continued)

LENGTH	VOLTS	WATTS	14" LEADS	PRICE	26" LEADS	PRICE	38" LEADS	PRICE
4	120	400	HTSS25040F-14S	\$44.67	HTSS25040F-26S	\$50.39	HTSS25040F-38S	\$56.10
4	240	400	HTSS25040A-14S	\$44.67	HTSS25040A-26S	\$50.39	HTSS25040A-38S	\$56.10
4.5	120	200	HTSS25045A-14S	\$44.67	HTSS25045A-26S	\$50.39	HTSS25045A-38S	\$56.10
5	120	125	HTSS25050A-14S	\$49.08	HTSS25050A-26S	\$54.80	HTSS25050A-38S	\$60.51
5	120	300	HTSS25050B-14S	\$49.08	HTSS25050B-26S	\$54.80	HTSS25050B-38S	\$60.51
5	120	500	HTSS25050C-14S	\$49.08	HTSS25050C-26S	\$54.80	HTSS25050C-38S	\$60.51
5	240	500	HTSS25050A-14S	\$49.08	HTSS25050A-26S	\$54.80	HTSS25050A-38S	\$60.51
6	120	150	HTSS25060A-14S	\$53.42	HTSS25060A-26S	\$59.14	HTSS25060A-38S	\$64.85
6	240	150	HTSS25060B-14S	\$53.42	HTSS25060B-26S	\$59.14	HTSS25060B-38S	\$64.85
6	120	600	HTSS25060C-14S	\$53.42	HTSS25060C-26S	\$59.14	HTSS25060C-38S	\$64.85
6	240	600	HTSS25060A-14S	\$53.42	HTSS25060A-26S	\$59.14	HTSS25060A-38S	\$64.85
7	120	300	HTSS25070A-14S	\$57.83	HTSS25070A-26S	\$63.55	HTSS25070A-38S	\$69.26
7	240	300	HTSS25070B-14S	\$57.83	HTSS25070B-26S	\$63.55	HTSS25070B-38S	\$69.26
8	120	400	HTSS25080A-14S	\$62.24	HTSS25080A-26S	\$67.96	HTSS25080A-38S	\$73.67
8	240	400	HTSS25080B-14S	\$62.24	HTSS25080B-26S	\$67.96	HTSS25080B-38S	\$73.67
10	240	500	HTSS25100A-14S	\$68.26	HTSS25100A-26S	\$73.74	HTSS25080A-38S	\$79.65
12	240	500	HTSS25120A-14S	\$74.00	HTSS25120A-26S	\$78.40	HTSS25120A-38S	\$84.78

**Do not see what you need?**

**We can build to your specifications!**

# .25" Diameter Options Selection

## Lead Options



Price	No Additional Charge
-------	----------------------

### Solid Nickel Pins

Utilized in high heat applications and where there is no movement or vibration. Lead wires can be added via exterior crimps. Damaged wires can be replaced quickly.



Price	First 14"	Per Additional 12"
	No Charge	\$2.79

### Fiberglass Leads (Standard)

Pure nickel conductors insulated with 950°F fiberglass insulation.



Price	First 14"	Per Additional 12"
	\$3.73	\$1.89

### Silicon Leads

Ideal for high-movement, limited heat applications. Can withstand temperatures up to 450°F. Provides limited protection to moisture. Requires silicon potting to be utilized.



Price	First 14"	Per Additional 12"
	\$3.73	\$1.89

### Teflon Leads

Ideal for excessive movement and high vibration applications. Can withstand temperatures up to 450°F. Provides limited protection from moisture. Requires either silicon potting or a Teflon seal.

# .25" Diameter Options Selection

## Lead Protection Options



Price	First 12"	Per Additional 12"
	\$3.99	\$1.78

### Fiberglass Sleeving

Protection against temperatures up to 950°F while providing moderate protection against friction.



Price	First 12"	Per additional 12"
	\$9.89	\$4.15

### Braided Metal Sleeving (BMS)

Ideal for high friction and constant bending. Stainless steel construction with high flexibility.



Price	First 12"	Per additional 12"
	\$13.25	\$5.55

### Armor Conduit

Water resistant interlocking design allows for limited exposure to moisture. Flexibility allows an added level of protection against physical damage to the lead wires.

**All options can be added to stock items and shipped within 24 hours of ordering!**

# .25" Diameter Options Selections

## NPT Fittings

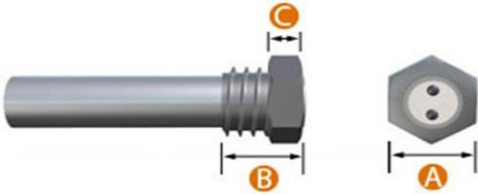

	Stainless Steel	Brass
Price	\$15.89	\$13.97

Specifications	1/4" Diameter
A	.433"
B	.625"
C	.157"
NPT Fitting	1/8

## Right Angle Block Exit with Knockout Tab

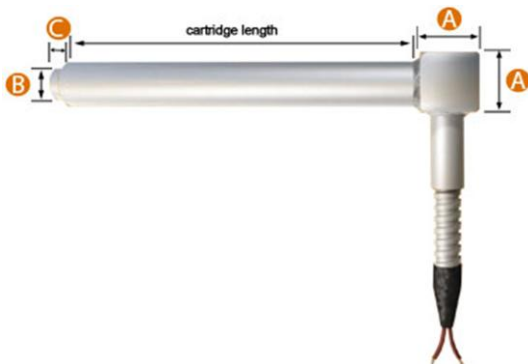

	Right Angle Block	Knockout Tab
Price	\$16.20	\$6.73

Specifications	1/4" Diameter
A (Right Angle Block)	.315"
B (Knockout Tab)	.157"
C (Knockout Tab)	.118"

**All options can be added to stock items and shipped within 24 hours of ordering!**

# .25" Diameter Options Selections

## Flange



Specifications		
A	1.00"	1.50"
B	0.75"	1.10"
C	.177"	.177"

Specifications	1" Flange	1.5" Flange
Price	\$10.20	\$10.73

## Mounting Tab



Specifications	
A	.240"
B	.315"
C	.393"

Price	\$10.20
-------	---------

**All options can be added to stock items and shipped within 24 hours of ordering!**

# .25" Diameter Options Selections

## Optional Exit Styles

### Right Angle Exit

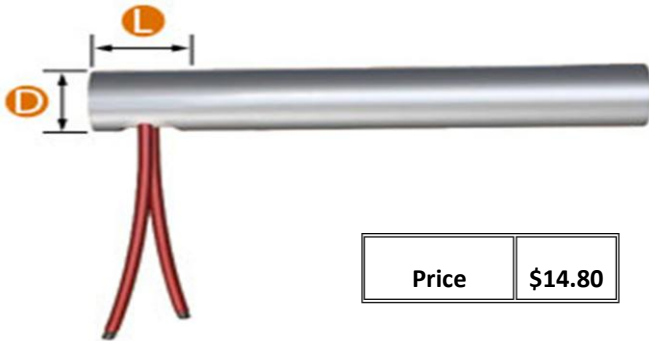

Price	\$14.80
-------	---------

Specifications	
D	.240"
L	.500"

### Right Angle Exit with Stress Relief Tube

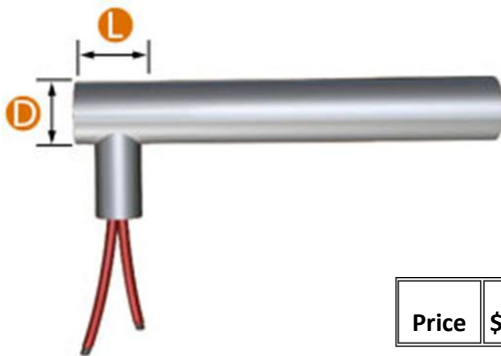

Price	\$17.80
-------	---------

Specifications	
D	.240"
L	.500"

### Right Angle Elbow

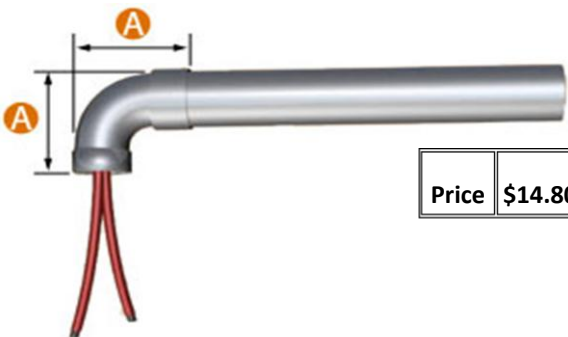

Price	\$14.80
-------	---------

Specifications	
A	.625"

All options can be added to stock items and shipped within 24 hours of ordering!

## Stock .375" Diameter Heaters

LENGTH	VOLTS	WATTS	14" LEADS	PRICE	26" LEADS	PRICE	38" LEADS	PRICE
1	240	100	HTSS37010A-14S	\$29.51	HTSS37010A-26S	\$35.73	HTSS37010A-38S	\$41.94
1.25	240	100	HTSS37012A-14S	\$32.31	HTSS37012A-26S	\$38.53	HTSS37012A-38S	\$44.74
1.25	240	150	HTSS37012B-14S	\$32.31	HTSS37012B-26S	\$38.53	HTSS37012B-38S	\$44.74
1.5	120	50	HTSS37015A-14S	\$32.31	HTSS37015A-26S	\$38.53	HTSS37015A-38S	\$44.74
1.5	120	100	HTSS37015B-14S	\$32.31	HTSS37015B-26S	\$38.53	HTSS37015B-38S	\$44.74
1.5	240	100	HTSS37015C-14S	\$32.31	HTSS37015C-26S	\$38.53	HTSS37015C-38S	\$44.74
1.5	120	150	HTSS37015D-14S	\$32.31	HTSS37015D-26S	\$38.53	HTSS37015D-38S	\$44.74
1.5	240	150	HTSS37015E-14S	\$32.31	HTSS37015E-26S	\$38.53	HTSS37015E-38S	\$44.74
1.5	120	200	HTSS37015F-14S	\$32.31	HTSS37015F-26S	\$38.53	HTSS37015F-38S	\$44.74
1.5	240	200	HTSS37015A-14S	\$32.31	HTSS37015A-26S	\$38.53	HTSS37015A-38S	\$44.74
1.5	120	250	HTSS37015H-14S	\$32.31	HTSS37015H-26S	\$38.53	HTSS37015H-38S	\$44.74
1.5	240	250	HTSS37015J-14S	\$32.31	HTSS37015J-26S	\$38.53	HTSS37015J-38S	\$44.74
1.75	120	50	HTSS37017A-14S	\$37.28	HTSS37017A-26S	\$43.50	HTSS37017A-38S	\$49.71
1.75	240	200	HTSS37017A-14S	\$37.28	HTSS37017A-26S	\$43.50	HTSS37017A-38S	\$49.71
2	120	50	HTSS37020A-14S	\$37.28	HTSS37020A-26S	\$43.50	HTSS37020A-38S	\$49.71
2	120	75	HTSS37020B-14S	\$37.28	HTSS37020B-26S	\$43.50	HTSS37020B-38S	\$49.71
2	120	100	HTSS37020C-14S	\$37.28	HTSS37020C-26S	\$43.50	HTSS37020C-38S	\$49.71
2	240	100	HTSS37020D-14S	\$37.28	HTSS37020D-26S	\$43.50	HTSS37020D-38S	\$49.71
2	120	150	HTSS37020E-14S	\$37.28	HTSS37020E-26S	\$43.50	HTSS37020E-38S	\$49.71
2	240	150	HTSS37020F-14S	\$37.28	HTSS37020F-26S	\$43.50	HTSS37020F-38S	\$49.71
2	120	200	HTSS37020G-14S	\$37.28	HTSS37020G-26S	\$43.50	HTSS37020G-38S	\$49.71
2	240	200	HTSS37020A-14S	\$37.28	HTSS37020A-26S	\$43.50	HTSS37020A-38S	\$49.71
2	120	250	HTSS37020M-14S	\$37.28	HTSS37020M-26S	\$43.50	HTSS37020M-38S	\$49.71
2	240	250	HTSS37020J-14S	\$37.28	HTSS37020J-26S	\$43.50	HTSS37020J-38S	\$49.71
2	120	300	HTSS37020K-14S	\$37.28	HTSS37020K-26S	\$43.50	HTSS37020K-38S	\$49.71
2	240	300	HTSS37020B-14S	\$37.28	HTSS37020B-26S	\$43.50	HTSS37020B-38S	\$49.71
2.5	120	250	HTSS37025A-14S	\$37.28	HTSS37025A-26S	\$43.50	HTSS37025A-38S	\$49.71
2.5	240	250	HTSS37025B-14S	\$37.28	HTSS37025B-26S	\$43.50	HTSS37025B-38S	\$49.71
3	120	100	HTSS37030A-14S	\$42.25	HTSS37030A-26S	\$48.47	HTSS37030A-38S	\$54.68
3	120	125	HTSS37030B-14S	\$42.25	HTSS37030B-26S	\$48.47	HTSS37030B-38S	\$54.68
3	120	150	HTSS37030K-14S	\$42.25	HTSS37030K-26S	\$48.47	HTSS37030K-38S	\$54.68

## Stock .375" Diameter Heaters (Continued)

LENGTH	VOLTS	WATTS	14" LEADS	PRICE	26" LEADS	PRICE	38" LEADS	PRICE
3	240	150	HTSS37030L-14S	\$42.25	HTSS37030L-26S	\$48.47	HTSS37030L-38S	\$54.68
3	120	200	HTSS37030C-14S	\$42.25	HTSS37030C-26S	\$48.47	HTSS37030C-38S	\$54.68
3	240	200	HTSS37030D-14S	\$42.25	HTSS37030D-26S	\$48.47	HTSS37030D-38S	\$54.68
3	120	250	HTSS37030E-14S	\$42.25	HTSS37030E-26S	\$48.47	HTSS37030E-38S	\$54.68
3	240	250	HTSS37030F-14S	\$42.25	HTSS37030F-26S	\$48.47	HTSS37030F-38S	\$54.68
3	120	300	HTSS37030G-14S	\$42.25	HTSS37030G-26S	\$48.47	HTSS37030G-38S	\$54.68
3	240	300	HTSS37030H-14S	\$42.25	HTSS37030H-26S	\$48.47	HTSS37030H-38S	\$54.68
3	120	400	HTSS37030J-14S	\$42.25	HTSS37030J-26S	\$48.47	HTSS37030J-38S	\$54.68
3	240	400	HTSS37030A-14S	\$42.25	HTSS37030A-26S	\$48.47	HTSS37030A-38S	\$54.68
3	120	500	HTSS37030L-14S	\$42.25	HTSS37030L-26S	\$48.47	HTSS37030L-38S	\$54.68
3	240	500	HTSS37030B-14S	\$42.25	HTSS37030B-26S	\$48.47	HTSS37030B-38S	\$54.68
3.5	120	75	HTSS37035A-14S	\$42.25	HTSS37035A-26S	\$48.47	HTSS37035A-38S	\$54.68
3.5	120	125	HTSS37035D-14S	\$42.25	HTSS37035D-26S	\$48.47	HTSS37035D-38S	\$54.68
3.5	120	300	HTSS37035B-14S	\$42.25	HTSS37035B-26S	\$48.47	HTSS37035B-38S	\$54.68
3.5	240	300	HTSS37035A-14S	\$42.25	HTSS37035A-26S	\$48.47	HTSS37035A-38S	\$54.68
3.5	120	500	HTSS37035C-14S	\$42.25	HTSS37035C-26S	\$48.47	HTSS37035C-38S	\$54.68
3.5	240	500	HTSS37035D-14S	\$42.25	HTSS37035D-26S	\$48.47	HTSS37035D-38S	\$54.68
4	120	125	HTSS37040A-14S	\$47.22	HTSS37040A-26S	\$53.44	HTSS37040A-38S	\$59.65
4	120	150	HTSS37040B-14S	\$47.22	HTSS37040B-26S	\$53.44	HTSS37040B-38S	\$59.65
4	240	150	HTSS37040H-14S	\$47.22	HTSS37040H-26S	\$53.44	HTSS37040H-38S	\$59.65
4	120	250	HTSS37040C-14S	\$47.22	HTSS37040C-26S	\$53.44	HTSS37040C-38S	\$59.65
4	240	250	HTSS37040D-14S	\$47.22	HTSS37040D-26S	\$53.44	HTSS37040D-38S	\$59.65
4	120	400	HTSS37040E-14S	\$47.22	HTSS37040E-26S	\$53.44	HTSS37040E-38S	\$59.65
4	240	400	HTSS37040F-14S	\$47.22	HTSS37040F-26S	\$53.44	HTSS37040F-38S	\$59.65
4	120	500	HTSS37040G-14S	\$47.22	HTSS37040G-26S	\$53.44	HTSS37040G-38S	\$59.65
4	240	500	HTSS37040A-14S	\$47.22	HTSS37040A-26S	\$53.44	HTSS37040A-38S	\$59.65
4	240	600	HTSS37040B-14S	\$47.22	HTSS37040B-26S	\$53.44	HTSS37040B-38S	\$59.65
4.5	120	125	HTSS37045A-14S	\$47.22	HTSS37045A-26S	\$53.44	HTSS37045A-38S	\$59.65
4.5	120	300	HTSS37045B-14S	\$47.22	HTSS37045B-26S	\$53.44	HTSS37045B-38S	\$59.65
4.5	120	500	HTSS37045C-14S	\$47.22	HTSS37045C-26S	\$53.44	HTSS37045C-38S	\$59.65
4.5	240	500	HTSS37045A-14S	\$47.22	HTSS37045A-26S	\$53.44	HTSS37045A-38S	\$59.65
5	120	100	HTSS37050E-14S	\$50.22	HTSS37050E-26S	\$56.44	HTSS37050E-38S	\$64.62

## Stock .375" Diameter Heaters (Continued)

LENGTH	VOLTS	WATTS	14" LEADS	PRICE	26" LEADS	PRICE	38" LEADS	PRICE
5	120	125	HTSS37050N-14S	\$52.19	HTSS37050N-26S	\$58.41	HTSS37050N-38S	\$64.62
5	120	150	HTSS37050B-14S	\$52.19	HTSS37050B-26S	\$58.41	HTSS37050B-38S	\$64.62
5	240	150	HTSS37050J-14S	\$52.19	HTSS37050J-26S	\$58.41	HTSS37050J-38S	\$64.62
5	120	200	HTSS37050H-14S	\$52.19	HTSS37050H-26S	\$58.41	HTSS37050H-38S	\$64.62
5	120	250	HTSS37050C-14S	\$52.19	HTSS37050C-26S	\$58.41	HTSS37050C-38S	\$64.62
5	120	300	HTSS37050K-14S	\$52.19	HTSS37050K-26S	\$58.41	HTSS37050K-38S	\$64.62
5	240	300	HTSS37050L-14S	\$52.19	HTSS37050L-26S	\$58.41	HTSS37050L-38S	\$64.62
5	120	400	HTSS37050D-14S	\$52.19	HTSS37050D-26S	\$58.41	HTSS37050D-38S	\$64.62
5	240	400	HTSS37050E-14S	\$52.19	HTSS37050E-26S	\$58.41	HTSS37050E-38S	\$64.62
5	120	500	HTSS37050M-14S	\$52.19	HTSS37050M-26S	\$58.41	HTSS37050M-38S	\$64.62
5	240	500	HTSS37050N-14S	\$52.19	HTSS37050N-26S	\$58.41	HTSS37050N-38S	\$64.62
5	120	600	HTSS37050F-14S	\$52.19	HTSS37050F-26S	\$58.41	HTSS37050F-38S	\$64.62
5	240	600	HTSS37050B-14S	\$52.19	HTSS37050B-26S	\$58.41	HTSS37050B-38S	\$64.62
5	240	800	HTSS37050H-14S	\$52.19	HTSS37050H-26S	\$58.41	HTSS37050H-38S	\$64.62
5	240	1000	HTSS37050C-14S	\$52.19	HTSS37050C-26S	\$58.41	HTSS37050C-38S	\$64.62
6	120	100	HTSS37060E-14S	\$57.16	HTSS37060E-26S	\$63.38	HTSS37060E-38S	\$69.59
6	120	125	HTSS37060K-14S	\$57.16	HTSS37060K-26S	\$63.38	HTSS37060K-38S	\$69.59
6	120	150	HTSS37060A-14S	\$57.16	HTSS37060A-26S	\$63.38	HTSS37060A-38S	\$69.59
6	120	200	HTSS37060B-14S	\$57.16	HTSS37060B-26S	\$63.38	HTSS37060B-38S	\$69.59
6	120	250	HTSS37060C-14S	\$57.16	HTSS37060C-26S	\$63.38	HTSS37060C-38S	\$69.59
6	240	250	HTSS37060F-14S	\$57.16	HTSS37060F-26S	\$63.38	HTSS37060F-38S	\$69.59
6	120	300	HTSS37060G-14S	\$57.16	HTSS37060G-26S	\$63.38	HTSS37060G-38S	\$69.59
6	240	300	HTSS37060H-14S	\$57.16	HTSS37060H-26S	\$63.38	HTSS37060H-38S	\$69.59
6	120	400	HTSS37060D-14S	\$57.16	HTSS37060D-26S	\$63.38	HTSS37060D-38S	\$69.59
6	240	400	HTSS37060E-14S	\$57.16	HTSS37060E-26S	\$63.38	HTSS37060E-38S	\$69.59
6	120	500	HTSS37060J-14S	\$57.16	HTSS37060J-26S	\$63.38	HTSS37060J-38S	\$69.59
6	240	500	HTSS37060K-14S	\$57.16	HTSS37060K-26S	\$63.38	HTSS37060K-38S	\$69.59
6	240	600	HTSS37060A-14S	\$57.16	HTSS37060A-26S	\$63.38	HTSS37060A-38S	\$69.59
6	240	800	HTSS37060B-14S	\$57.16	HTSS37060B-26S	\$63.38	HTSS37060B-38S	\$69.59
6	240	1000	HTSS37060C-14S	\$57.16	HTSS37060C-26S	\$63.38	HTSS37060C-38S	\$69.59
6.5	120	500	HTSS37065A-14S	\$57.16	HTSS37065A-26S	\$63.38	HTSS37065A-38S	\$69.59
6.5	240	500	HTSS37065B-14S	\$57.16	HTSS37065B-26S	\$63.38	HTSS37065B-38S	\$69.59
7	120	250	HTSS37070A-14S	\$62.13	HTSS37070A-26S	\$68.35	HTSS37070A-38S	\$74.56
7	120	400	HTSS37070B-14S	\$62.13	HTSS37070B-26S	\$68.35	HTSS37070B-38S	\$64.62

## Stock .375" Diameter Heaters (Continued)

LENGTH	VOLTS	WATTS	14" LEADS	PRICE	26" LEADS	PRICE	38" LEADS	PRICE
7	240	400	HTSS37070C-14S	\$62.13	HTSS37070C-26S	\$68.35	HTSS37070C-38S	\$74.56
7	120	500	HTSS37070D-14S	\$62.13	HTSS37070D-26S	\$68.35	HTSS37070D-38S	\$74.56
7	240	500	HTSS37070E-14S	\$62.13	HTSS37070E-26S	\$68.35	HTSS37070E-38S	\$74.56
7	120	600	HTSS37070F-14S	\$62.13	HTSS37070F-26S	\$68.35	HTSS37070F-38S	\$74.56
7	240	600	HTSS37070G-14S	\$62.13	HTSS37070G-26S	\$68.35	HTSS37070G-38S	\$74.56
7	240	1000	HTSS37070A-14S	\$62.13	HTSS37070A-26S	\$68.35	HTSS37070A-38S	\$74.56
7.5	240	500	HTSS37075A-14S	\$62.13	HTSS37075A-26S	\$68.35	HTSS37075A-38S	\$74.56
8	120	250	HTSS37080A-14S	\$67.03	HTSS37080A-26S	\$73.25	HTSS37080A-38S	\$79.46
8	120	300	HTSS37080C-14S	\$67.03	HTSS37080C-26S	\$73.25	HTSS37080C-38S	\$79.46
8	240	300	HTSS37080D-14S	\$67.03	HTSS37080D-26S	\$73.25	HTSS37080D-38S	\$79.46
8	120	500	HTSS37080E-14S	\$67.03	HTSS37080E-26S	\$73.25	HTSS37080E-38S	\$79.46
8	240	500	HTSS37080F-14S	\$67.03	HTSS37080F-26S	\$73.25	HTSS37080F-38S	\$79.46
8	120	600	HTSS37080H-14S	\$67.03	HTSS37080H-26S	\$73.25	HTSS37080H-38S	\$79.46
8	240	600	HTSS37080B-14S	\$67.03	HTSS37080B-26S	\$73.25	HTSS37080B-38S	\$79.46
8	240	750	HTSS37080G-14S	\$67.03	HTSS37080G-26S	\$73.25	HTSS37080G-38S	\$79.46
8	240	1000	HTSS37080A-14S	\$67.03	HTSS37080A-26S	\$73.25	HTSS37080A-38S	\$79.46
9	120	250	HTSS37090A-14S	\$72.00	HTSS37090A-26S	\$78.22	HTSS37090A-38S	\$84.43
9	120	400	HTSS37090B-14S	\$72.00	HTSS37090B-26S	\$78.22	HTSS37090B-38S	\$84.43
9	240	400	HTSS37090C-14S	\$72.00	HTSS37090C-26S	\$78.22	HTSS37090C-38S	\$84.43
9	240	1000	HTSS37090A-14S	\$72.00	HTSS37090A-26S	\$78.22	HTSS37090A-38S	\$84.43
10	120	250	HTSS37100A-14S	\$76.97	HTSS37100A-26S	\$83.19	HTSS37100A-38S	\$89.40
10	120	400	HTSS37100C-14S	\$76.97	HTSS37100C-26S	\$83.19	HTSS37100C-38S	\$89.40
10	120	600	HTSS37100D-14S	\$76.97	HTSS37100D-26S	\$83.19	HTSS37100D-38S	\$89.40
10	240	600	HTSS37100B-14S	\$76.97	HTSS37100B-26S	\$83.19	HTSS37100B-38S	\$89.40
10	240	1000	HTSS37100A-14S	\$76.97	HTSS37100A-26S	\$83.19	HTSS37100A-38S	\$89.40
11	240	1000	HTSS37110A-14S	\$81.87	HTSS37110A-26S	\$88.09	HTSS37110A-38S	\$94.30
12	120	250	HTSS37120A-14S	\$86.84	HTSS37120A-26S	\$93.06	HTSS37120A-38S	\$99.27
12	120	500	HTSS37120D-14S	\$86.84	HTSS37120D-26S	\$93.06	HTSS37120D-38S	\$99.27
12	240	500	HTSS37120E-14S	\$86.84	HTSS37120E-26S	\$93.06	HTSS37120E-38S	\$99.27
12	120	600	HTSS37120F-14S	\$86.84	HTSS37120F-26S	\$93.06	HTSS37120F-38S	\$99.27
12	240	600	HTSS37120B-14S	\$86.84	HTSS37120B-26S	\$93.06	HTSS37120B-38S	\$99.27
12	240	750	HTSS37120G-14S	\$86.84	HTSS37120G-26S	\$93.06	HTSS37120G-38S	\$99.27
12	240	1000	HTSS37120A-14S	\$86.84	HTSS37120A-26S	\$93.06	HTSS37120A-38S	\$99.27
12	240	1500	HTSS37120C-14S	\$86.84	HTSS37120C-26S	\$93.06	HTSS37120C-38S	\$99.27

## Stock .375" Diameter Heaters (Continued)

LENGTH	VOLTS	WATTS	14" LEADS	PRICE	26" LEADS	PRICE	38" LEADS	PRICE
14	240	600	HTSS37140A-14S	\$96.78	HTSS37140A-26S	\$103.00	HTSS37140A-38S	\$109.21
14	240	1000	HTSS37140B-14S	\$96.78	HTSS37140B-26S	\$103.00	HTSS37140B-38S	\$109.21
15	240	1000	HTSS37150A-14S	\$101.75	HTSS37150A-26S	\$107.97	HTSS37150A-38S	\$114.18
16	240	1000	HTSS37160A-14S	\$106.79	HTSS37160A-26S	\$113.01	HTSS37160A-38S	\$119.22
21	240	1000	HTSS37210A-14S	\$131.64	HTSS37210A-26S	\$137.86	HTSS37210A-38S	\$144.07

**Do not see what you need?**

**We can build to your specifications!**

# .375" Diameter Options Selection

## Lead Options



Price	No Additional Charge
-------	----------------------

### Solid Nickel Pins

Utilized in high heat applications and where there is no movement or vibration. Lead wires can be added via exterior crimps. Damaged wires can be replaced quickly.



Price	First 14"	Per Additional 12"
	No Charge	\$2.79

### Fiberglass Leads (Standard)

Pure nickel conductors insulated with 950°F fiberglass insulation.



Price	First 14"	Per Additional 12"
	\$3.73	\$1.89

### Silicon Leads

Ideal for high movement applications where there is limited heat. Can withstand temperatures up to 450°F. Provides limited protection to moisture. Requires Silicon Potting to be utilized.



Price	First 14"	Per Additional 12"
	\$3.73	\$1.89

### Teflon Leads

Ideal for excessive movement and high vibration applications. Can withstand moderate temperatures 450°F. Provides limited protection from moisture. Requires either silicon potting or a Teflon seal.

# .375" Diameter Options Selection

## Lead Protection Options



Price	First 12"	Per Additional 12"
	\$3.99	\$1.78

### Fiberglass Sleeving

Protection against temperatures up to 950°F while providing moderate protection against friction.



Price	First 12"	Per additional 12"
	\$9.89	\$4.15

### Braided Metal Sleeving (BMS)

Ideal for high friction and constant bending. Stainless steel construction with high flexibility.



Price	First 12"	Per additional 12"
	\$13.25	\$5.55

### Armor Conduit

Water resistant interlocking design allows for limited exposure to moisture. Flexibility allows an added level of protection against physical damage to the lead wires.

**All options can be added to stock items and shipped within 24 hours of ordering!**

# .375" Diameter Options Selection

## NPT Fittings

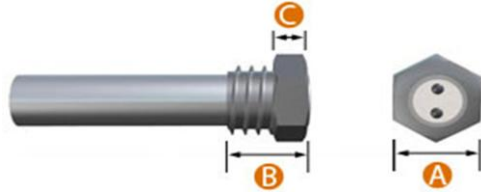

	Stainless Steel	Brass
Price	\$15.89	\$13.97

Specifications	3/8" Diameter
A	.590"
B	.750"
C	.250"
NPT Fitting	1/4

## Right Angle Block Exit with Knockout Tab

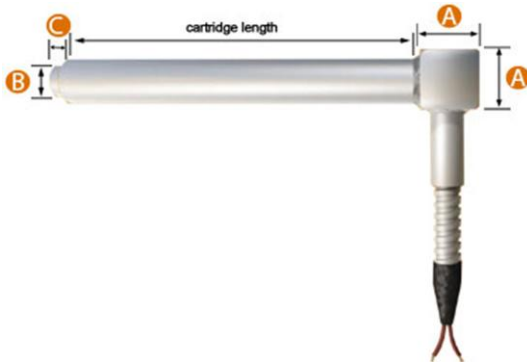

Specifications	
A	.475"
B	.355"
C	.157"

	Right Angle Block	Knockout Tab
Price	\$19.20	\$6.73

**All options can be added to stock items and shipped within 24 hours of ordering!**

# .375" Diameter Options Selection

## Optional Exit Styles

### Right Angle Exit

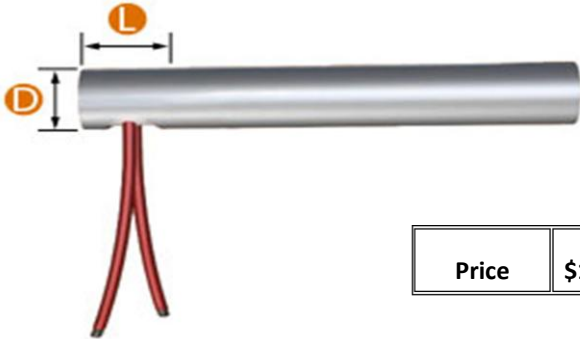

Price	\$11.80
-------	---------

Specifications	
D	.375"
L	.625"

### Right Angle Exit with Stress Relief Tube

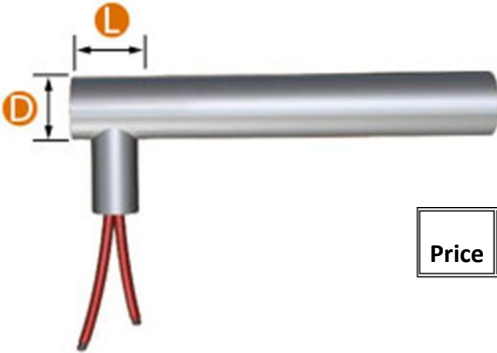

Price	\$13.80
-------	---------

Specifications	
D	.375"
L	.625"

### Right Angle Elbow

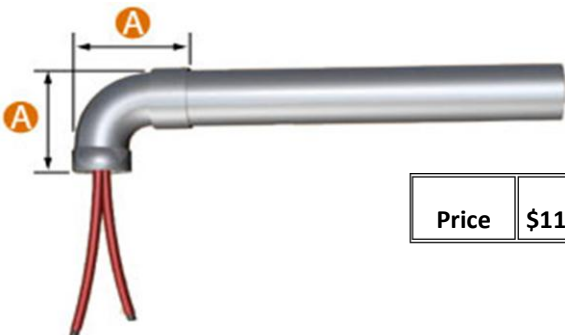

Price	\$11.80
-------	---------

Specifications	
A	.625"

**All options can be added to stock items and shipped within 24 hours of ordering!**

## Stock .5" Diameter Heaters

LENGTH	VOLTS	WATTS	14" LEADS	PRICE	26" LEADS	PRICE	38" LEADS	PRICE
1.5	120	50	HTSS50015A-14S	\$36.32	HTSS50015A-26S	\$42.59	HTSS50015A-38S	\$48.80
1.5	120	200	HTSS50015B-14S	\$36.32	HTSS50015B-26S	\$42.59	HTSS50015B-38S	\$48.80
1.5	240	200	HTSS50015A-14S	\$36.32	HTSS50015A-26S	\$42.59	HTSS50015A-38S	\$48.80
2	120	75	HTSS50020A-14S	\$42.90	HTSS50020A-26S	\$49.17	HTSS50020A-38S	\$55.38
2	120	100	HTSS50020B-14S	\$42.90	HTSS50020B-26S	\$49.17	HTSS50020A-38S	\$55.38
2	240	200	HTSS50020C-14S	\$42.90	HTSS50020C-26S	\$49.17	HTSS50020C-38S	\$55.38
2	240	300	HTSS50020A-14S	\$42.90	HTSS50020A-26S	\$49.17	HTSS50020A-38S	\$55.38
2	240	400	HTSS50020B-14S	\$42.90	HTSS50020B-26S	\$49.17	HTSS50020B-38S	\$55.38
2.5	120	75	HTSS50025A-14S	\$42.90	HTSS50025A-26S	\$49.17	HTSS50025A-38S	\$55.38
2.5	120	100	HTSS50025B-14S	\$42.90	HTSS50025B-26S	\$49.17	HTSS50025B-38S	\$55.38
2.5	120	125	HTSS50025C-14S	\$42.90	HTSS50025C-26S	\$49.17	HTSS50025C-38S	\$55.38
2.5	240	300	HTSS50025A-14S	\$42.90	HTSS50025A-26S	\$49.17	HTSS50025A-38S	\$55.38
2.5	240	400	HTSS50025B-14S	\$42.90	HTSS50025B-26S	\$49.17	HTSS50025B-38S	\$55.38
2.5	240	500	HTSS50025C-14S	\$42.90	HTSS50025C-26S	\$49.17	HTSS50025C-38S	\$55.38
3	120	100	HTSS50030F-14S	\$49.48	HTSS50030F-26S	\$55.75	HTSS50030F-38S	\$61.96
3	120	125	HTSS50030G-14S	\$49.48	HTSS50030G-26S	\$55.75	HTSS50030G-38S	\$61.96
3	240	125	HTSS50030A-14S	\$49.48	HTSS50030A-26S	\$55.75	HTSS50030A-38S	\$61.96
3	120	250	HTSS50030B-14S	\$49.48	HTSS50030B-26S	\$55.75	HTSS50030B-38S	\$61.96
3	240	250	HTSS50030C-14S	\$49.48	HTSS50030C-26S	\$55.75	HTSS50030C-38S	\$61.96
3	120	300	HTSS50030H-14S	\$49.48	HTSS50030H-26S	\$55.75	HTSS50030H-38S	\$61.96
3	240	300	HTSS50030D-14S	\$49.48	HTSS50030D-26S	\$55.75	HTSS50030D-38S	\$61.96
3	120	400	HTSS50030E-14S	\$49.48	HTSS50030E-26S	\$55.75	HTSS50030E-38S	\$61.96
3	240	400	HTSS50030F-14S	\$49.48	HTSS50030F-26S	\$55.75	HTSS50030F-38S	\$61.96
3	120	500	HTSS50030J-14S	\$49.48	HTSS50030J-26S	\$55.75	HTSS50030J-38S	\$61.96
3	240	500	HTSS50030A-14S	\$49.48	HTSS50030A-26S	\$55.75	HTSS50030A-38S	\$61.96
3.5	120	125	HTSS50035A-14S	\$49.48	HTSS50035A-26S	\$55.75	HTSS50035A-38S	\$61.96
3.5	240	250	HTSS50035B-14S	\$49.48	HTSS50035B-26S	\$55.75	HTSS50035B-38S	\$61.96
3.5	240	400	HTSS50035C-14S	\$49.48	HTSS50035C-26S	\$55.75	HTSS50035C-38S	\$61.96
3.5	240	500	HTSS50035A-14S	\$49.48	HTSS50035A-26S	\$55.75	HTSS50035A-38S	\$61.96
3.5	240	750	HTSS50035D-14S	\$49.48	HTSS50035D-26S	\$55.75	HTSS50035D-38S	\$61.96
4	240	125	HTSS50040A-14S	\$56.06	HTSS50040A-26S	\$62.33	HTSS50040A-38S	\$68.54

## Stock .5" Diameter Heaters (Continued)

LENGTH	VOLTS	WATTS	14" LEADS	PRICE	26" LEADS	PRICE	38" LEADS	PRICE
4	120	150	HTSS50040M-14S	\$56.06	HTSS50040M-26S	\$62.33	HTSS50040M-38S	\$68.54
4	120	200	HTSS50040J-14S	\$56.06	HTSS50040J-26S	\$62.33	HTSS50040J-38S	\$68.54
4	120	250	HTSS50040K-14S	\$56.06	HTSS50040K-26S	\$62.33	HTSS50040K-38S	\$68.54
4	240	250	HTSS50040B-14S	\$56.06	HTSS50040B-26S	\$62.33	HTSS50040B-38S	\$68.54
4	120	300	HTSS50040C-14S	\$56.06	HTSS50040C-26S	\$62.33	HTSS50040C-38S	\$68.54
4	240	300	HTSS50040D-14S	\$56.06	HTSS50040D-26S	\$62.33	HTSS50040D-38S	\$68.54
4	120	400	HTSS50040E-14S	\$56.06	HTSS50040E-26S	\$62.33	HTSS50040E-38S	\$68.54
4	240	400	HTSS50040F-14S	\$56.06	HTSS50040F-26S	\$62.33	HTSS50040F-38S	\$68.54
4	120	500	HTSS50040L-14S	\$56.06	HTSS50040L-26S	\$62.33	HTSS50040L-38S	\$68.54
4	240	500	HTSS50040G-14S	\$56.06	HTSS50040G-26S	\$62.33	HTSS50040G-38S	\$68.54
4	240	600	HTSS50040M-14S	\$56.06	HTSS50040M-26S	\$62.33	HTSS50040M-38S	\$68.54
4	240	750	HTSS50040H-14S	\$56.06	HTSS50040H-26S	\$62.33	HTSS50040H-38S	\$68.54
4	240	800	HTSS50040J-14S	\$56.06	HTSS50040J-26S	\$62.33	HTSS50040J-38S	\$68.54
4	240	1000	HTSS50040K-14S	\$56.06	HTSS50040K-26S	\$62.33	HTSS50040K-38S	\$68.54
4.5	120	125	HTSS50045C-14S	\$56.06	HTSS50045C-26S	\$62.33	HTSS50045C-38S	\$68.54
4.5	120	175	HTSS50045B-14S	\$56.06	HTSS50045B-26S	\$62.33	HTSS50045B-38S	\$68.54
4.5	240	250	HTSS50045A-14S	\$56.06	HTSS50045A-26S	\$62.33	HTSS50045A-38S	\$68.54
4.5	240	500	HTSS50045C-14S	\$56.06	HTSS50045C-26S	\$62.33	HTSS50045C-38S	\$68.54
4.5	240	750	HTSS50045B-14S	\$56.06	HTSS50045B-26S	\$62.33	HTSS50045B-38S	\$68.54
5	120	200	HTSS50050A-14S	\$62.57	HTSS50050A-26S	\$68.84	HTSS50050A-38S	\$75.05
5	120	250	HTSS50050B-14S	\$62.57	HTSS50050B-26S	\$68.84	HTSS50050B-38S	\$75.05
5	240	250	HTSS50050F-14S	\$62.57	HTSS50050F-26S	\$68.84	HTSS50050F-38S	\$75.05
5	240	300	HTSS50050C-14S	\$62.57	HTSS50050C-26S	\$68.84	HTSS50050C-38S	\$75.05
5	120	500	HTSS50050D-14S	\$62.57	HTSS50050D-26S	\$68.84	HTSS50050D-38S	\$75.05
5	240	500	HTSS50050E-14S	\$62.57	HTSS50050E-26S	\$68.84	HTSS50050E-38S	\$75.05
5	240	800	HTSS50050A-14S	\$62.57	HTSS50050A-26S	\$68.84	HTSS50050A-38S	\$75.05
5	240	1000	HTSS50050B-14S	\$62.57	HTSS50050B-26S	\$68.84	HTSS50050B-38S	\$75.05
5.5	240	500	HTSS50055B-14S	\$62.57	HTSS50055B-26S	\$68.84	HTSS50055B-38S	\$75.05
5.5	240	750	HTSS50055A-14S	\$62.57	HTSS50055A-26S	\$68.84	HTSS50055A-38S	\$75.05
6	120	250	HTSS50060D-14S	\$69.15	HTSS50060D-26S	\$75.42	HTSS50060D-38S	\$81.63
6	240	250	HTSS50060E-14S	\$69.15	HTSS50060E-26S	\$75.42	HTSS50060E-38S	\$81.63
6	120	300	HTSS50060G-14S	\$69.15	HTSS50060G-26S	\$75.42	HTSS50060G-38S	\$81.63
6	240	300	HTSS50060H-14S	\$69.15	HTSS50060H-26S	\$75.42	HTSS50060H-38S	\$81.63

## Stock .5" Diameter Heaters (Continued)

LENGTH	VOLTS	WATTS	14" LEADS	PRICE	26" LEADS	PRICE	38" LEADS	PRICE
6	120	375	HTSS50060A-14S	\$69.15	HTSS50060A-26S	\$75.42	HTSS50060A-38S	\$81.63
6	240	400	HTSS50060J-14S	\$69.15	HTSS50060J-26S	\$75.42	HTSS50060J-38S	\$81.63
6	120	500	HTSS50060K-14S	\$69.15	HTSS50060K-26S	\$75.42	HTSS50060K-38S	\$81.63
6	240	500	HTSS50060B-14S	\$69.15	HTSS50060B-26S	\$75.42	HTSS50060B-38S	\$81.63
6	240	750	HTSS50060C-14S	\$69.15	HTSS50060C-26S	\$75.42	HTSS50060C-38S	\$81.63
6	120	1000	HTSS50060F-14S	\$69.15	HTSS50060F-26S	\$75.42	HTSS50060F-38S	\$81.63
6	240	1000	HTSS50060D-14S	\$69.15	HTSS50060D-26S	\$75.42	HTSS50060D-38S	\$81.63
6	240	1200	HTSS50060G-14S	\$69.15	HTSS50060G-26S	\$75.42	HTSS50060G-38S	\$81.63
6	240	1500	HTSS50060A-14S	\$69.15	HTSS50060A-26S	\$75.42	HTSS50060A-38S	\$81.63
6.5	120	250	HTSS50065A-14S	\$69.15	HTSS50065A-26S	\$75.42	HTSS50065A-38S	\$81.63
6.5	240	500	HTSS50065B-14S	\$69.15	HTSS50065B-26S	\$75.42	HTSS50065B-38S	\$81.63
6.5	240	1000	HTSS50065A-14S	\$69.15	HTSS50065A-26S	\$75.42	HTSS50065A-38S	\$81.63
7	120	250	HTSS50070A-14S	\$75.73	HTSS50070A-26S	\$82.00	HTSS50070A-38S	\$88.21
7	240	300	HTSS50070D-14S	\$75.73	HTSS50070D-26S	\$82.00	HTSS50070D-38S	\$88.21
7	120	500	HTSS50070E-14S	\$75.73	HTSS50070E-26S	\$82.00	HTSS50070E-38S	\$88.21
7	240	500	HTSS50070F-14S	\$75.73	HTSS50070F-26S	\$82.00	HTSS50070F-38S	\$88.21
7	120	600	HTSS50070B-14S	\$75.73	HTSS50070B-26S	\$82.00	HTSS50070B-38S	\$88.21
7	240	600	HTSS50070C-14S	\$75.73	HTSS50070C-26S	\$82.00	HTSS50070C-38S	\$88.21
7	240	750	HTSS50070G-14S	\$75.73	HTSS50070G-26S	\$82.00	HTSS50070G-38S	\$88.21
7	240	1000	HTSS50070A-14S	\$75.73	HTSS50070A-26S	\$82.00	HTSS50070A-38S	\$88.21
7.5	240	1000	HTSS50075A-14S	\$75.73	HTSS50075A-26S	\$82.00	HTSS50075A-38S	\$88.21
8	120	250	HTSS50080G-14S	\$82.24	HTSS50080G-26S	\$88.51	HTSS50080G-38S	\$94.72
8	240	250	HTSS50080K-14S	\$82.24	HTSS50080K-26S	\$88.51	HTSS50080K-38S	\$94.72
8	120	300	HTSS50080H-14S	\$82.24	HTSS50080H-26S	\$88.51	HTSS50080H-38S	\$94.72
8	120	375	HTSS50080A-14S	\$82.24	HTSS50080A-26S	\$88.51	HTSS50080A-38S	\$94.72
8	240	400	HTSS50080B-14S	\$82.24	HTSS50080B-26S	\$88.51	HTSS50080B-38S	\$94.72
8	120	500	HTSS50080J-14S	\$82.24	HTSS50080J-26S	\$88.51	HTSS50080J-38S	\$94.72
8	240	500	HTSS50080C-14S	\$82.24	HTSS50080C-26S	\$88.51	HTSS50080C-38S	\$94.72
8	120	750	HTSS50080D-14S	\$82.24	HTSS50080D-26S	\$88.51	HTSS50080D-38S	\$94.72
8	240	750	HTSS50080E-14S	\$82.24	HTSS50080E-26S	\$88.51	HTSS50080E-38S	\$94.72
8	120	1000	HTSS50080F-14S	\$82.24	HTSS50080F-26S	\$88.51	HTSS50080F-38S	\$94.72
8	240	1000	HTSS50080G-14S	\$82.24	HTSS50080G-26S	\$88.51	HTSS50080G-38S	\$94.72
8	480	1000	HTSS50080K-14S	\$82.24	HTSS50080K-26S	\$88.51	HTSS50080K-38S	\$94.72

## Stock .5" Diameter Heaters (Continued)

LENGTH	VOLTS	WATTS	14" LEADS	PRICE	26" LEADS	PRICE	38" LEADS	PRICE
8	240	1200	HTSS50080H-14S	\$82.24	HTSS50080H-26S	\$88.51	HTSS50080H-38S	\$94.72
8	240	1500	HTSS50080A-14S	\$82.24	HTSS50080A-26S	\$88.51	HTSS50080A-38S	\$94.72
8	240	2000	HTSS50080J-14S	\$82.24	HTSS50080J-26S	\$88.51	HTSS50080J-38S	\$94.72
8.5	240	500	HTSS50085A-14S	\$82.24	HTSS50085A-26S	\$88.51	HTSS50085A-38S	\$94.72
8.5	240	1000	HTSS50085B-14S	\$82.24	HTSS50085B-26S	\$88.51	HTSS50085B-38S	\$94.72
9	240	500	HTSS50090A-14S	\$88.82	HTSS50090A-26S	\$95.09	HTSS50090A-38S	\$101.30
9	240	1000	HTSS50090B-14S	\$88.82	HTSS50090B-26S	\$95.09	HTSS50090B-38S	\$101.30
9.5	240	1000	HTSS50095A-14S	\$88.82	HTSS50095A-26S	\$95.09	HTSS50095A-38S	\$101.30
10	120	500	HTSS50100A-14S	\$95.40	HTSS50100A-26S	\$101.67	HTSS50100A-38S	\$107.88
10	240	500	HTSS50100B-14S	\$95.40	HTSS50100B-26S	\$101.67	HTSS50100B-38S	\$107.88
10	240	600	HTSS50100F-14S	\$95.40	HTSS50100F-26S	\$101.67	HTSS50100F-38S	\$107.88
10	120	1000	HTSS50100C-14S	\$95.40	HTSS50100C-26S	\$101.67	HTSS50100C-38S	\$107.88
10	240	1000	HTSS50100D-14S	\$95.40	HTSS50100D-26S	\$101.67	HTSS50100D-38S	\$107.88
10	480	1000	HTSS50100G-14S	\$95.40	HTSS50100G-26S	\$101.67	HTSS50100G-38S	\$107.88
10	240	1500	HTSS50100E-14S	\$95.40	HTSS50100E-26S	\$101.67	HTSS50100E-38S	\$107.88
10	240	2000	HTSS50100A-14S	\$95.40	HTSS50100A-26S	\$101.67	HTSS50100A-38S	\$107.88
10	480	2000	HTSS50100H-14S	\$95.40	HTSS50100H-26S	\$101.67	HTSS50100H-38S	\$107.88
11	240	1000	HTSS50110A-14S	\$101.98	HTSS50110A-26S	\$108.25	HTSS50110A-38S	\$114.46
11	240	1600	HTSS50110B-14S	\$101.98	HTSS50110B-26S	\$108.25	HTSS50110B-38S	\$114.46
12	120	500	HTSS50120A-14S	\$108.49	HTSS50120A-26S	\$114.76	HTSS50120A-38S	\$120.97
12	240	500	HTSS50120E-14S	\$108.49	HTSS50120E-26S	\$114.76	HTSS50120E-38S	\$120.97
12	120	600	HTSS50120F-14S	\$108.49	HTSS50120F-26S	\$114.76	HTSS50120F-38S	\$120.97
12	240	600	HTSS50120B-14S	\$108.49	HTSS50120B-26S	\$114.76	HTSS50120B-38S	\$120.97
12	240	800	HTSS50120G-14S	\$108.49	HTSS50120G-26S	\$114.76	HTSS50120G-38S	\$120.97
12	120	1000	HTSS50120H-14S	\$108.49	HTSS50120H-26S	\$114.76	HTSS50120H-38S	\$120.97
12	240	1000	HTSS50120C-14S	\$108.49	HTSS50120C-26S	\$114.76	HTSS50120C-38S	\$120.97
12	480	1200	HTSS50120J-14S	\$108.49	HTSS50120J-26S	\$114.76	HTSS50120J-38S	\$120.97
12	240	1500	HTSS50120D-14S	\$108.49	HTSS50120D-26S	\$114.76	HTSS50120D-38S	\$120.97
12	240	2000	HTSS50120A-14S	\$108.49	HTSS50120A-26S	\$114.76	HTSS50120A-38S	\$120.97
12	240	2400	HTSS50120F-14S	\$108.49	HTSS50120F-26S	\$114.76	HTSS50120F-38S	\$120.97
12.5	240	1000	HTSS50125A-14S	\$108.49	HTSS50125A-26S	\$114.76	HTSS50125A-38S	\$120.97
13	240	1000	HTSS50130A-14S	\$115.07	HTSS50130A-26S	\$121.34	HTSS50130A-38S	\$127.55
14	120	1000	HTSS50140A-14S	\$121.65	HTSS50140A-26S	\$127.92	HTSS50140A-38S	\$134.13

## Stock .5" Diameter Heaters (Continued)

LENGTH	VOLTS	WATTS	14" LEADS	PRICE	26" LEADS	PRICE	38" LEADS	PRICE
14	240	1000	HTSS50140B-14S	\$121.65	HTSS50140B-26S	\$127.92	HTSS50140B-38S	\$134.13
14	240	2300	HTSS50140C-14S	\$121.65	HTSS50140C-26S	\$127.92	HTSS50140C-38S	\$134.13
15	240	1000	HTSS50150A-14S	\$128.23	HTSS50150A-26S	\$134.50	HTSS50150A-38S	\$140.71
15	240	1500	HTSS50150B-14S	\$128.23	HTSS50150B-26S	\$134.50	HTSS50150B-38S	\$140.71
15	240	2000	HTSS50150C-14S	\$128.23	HTSS50150C-26S	\$134.50	HTSS50150C-38S	\$140.71
16	120	800	HTSS50160A-14S	\$134.74	HTSS50160A-26S	\$141.01	HTSS50160A-38S	\$147.22
16	240	800	HTSS50160B-14S	\$134.74	HTSS50160B-26S	\$141.01	HTSS50160B-38S	\$147.22
16	240	1000	HTSS50160C-14S	\$134.74	HTSS50160C-26S	\$141.01	HTSS50160C-38S	\$147.22
16	240	1500	HTSS50160D-14S	\$134.74	HTSS50160D-26S	\$141.01	HTSS50160D-38S	\$147.22
16	240	2000	HTSS50160E-14S	\$134.74	HTSS50160E-26S	\$141.01	HTSS50160E-38S	\$147.22
18	240	1000	HTSS50180A-14S	\$147.90	HTSS50180A-26S	\$154.17	HTSS50180A-38S	\$160.38
18	240	1500	HTSS50180C-14S	\$147.90	HTSS50180C-26S	\$154.17	HTSS50180C-38S	\$160.38
18	480	1500	HTSS50180B-14S	\$147.90	HTSS50180B-26S	\$154.17	HTSS50180B-38S	\$160.38
20	240	1000	HTSS50200A-14S	\$154.48	HTSS50200A-26S	\$160.75	HTSS50200A-38S	\$166.96
20	240	1500	HTSS50200B-14S	\$154.48	HTSS50200B-26S	\$160.75	HTSS50200B-38S	\$166.96
24	240	1000	HTSS50240A-14S	\$187.24	HTSS50240A-26S	\$193.51	HTSS50240A-38S	\$199.72
24	240	2000	HTSS50240B-14S	\$187.24	HTSS50240B-26S	\$193.51	HTSS50240B-38S	\$199.72

**Do not see what you need?**

**We can build to your specifications!**

# .5" Diameter Options Selection

## Lead Options



Price	No Additional Charge
-------	----------------------

### Solid Nickel Pins

Utilized in high heat applications and where there is no movement or vibration. Lead wires can be added via exterior crimps. Damaged wires can be replaced quickly.



Price	First 14"	Per Additional 12"
	No Charge	\$2.79

### Fiberglass Leads (Standard)

Pure nickel conductors insulated with 950°F fiberglass insulation.



Price	First 14"	Per Additional 12"
	\$3.73	\$1.89

### Silicon Leads

Ideal for high movement applications where there is limited heat. Can withstand temperatures up to 450°F. Provides limited protection to moisture. Requires Silicon Potting to be utilized.



Price	First 14"	Per Additional 12"
	\$3.73	\$1.89

### Teflon Leads

Ideal for excessive movement and high vibration applications. Can withstand moderate temperatures 450°F. Provides limited protection from moisture. Requires either silicon potting or a Teflon seal.

# .5" Diameter Options Selection

## Lead Protection Options



Price	First 12"	Per Additional 12"
	\$3.99	\$1.78

### Fiberglass Sleeving

Protection against high temperatures up to 950°F while providing moderate protection against friction.



Price	First 12"	Per Additional 12"
	\$9.89	\$4.15

### Braided Metal Sleeving (BMS)

Ideal for high friction and constant bending. Stainless steel construction with high flexibility.



Price	First 12"	Per Additional 12"
	\$13.25	\$5.55

### Armor Conduit

Water resistant interlocking design allows for limited exposure to moisture. Flexibility allows an added level of protection against physical damage to the lead wires.

**All options can be added to stock items and shipped within 24 hours of ordering!**

# .5" Diameter Options Selection

## NPT Fittings

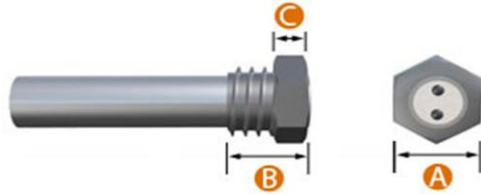

	Stainless Steel	Brass
Price	\$17.89	\$15.97

Specifications	.500" Diameter
A	.675"
B	.750"
C	.250"
NPT Fitting	3/8

## Right Angle Block Exit with Knockout Tab

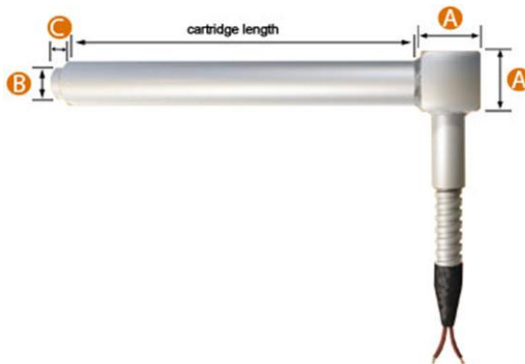

Specifications	
A	.550"
B	.355"
C	.157"

	Right Angle Block	Knockout Tab
Price	\$19.20	\$8.73

**All options can be added to stock items and shipped within 24 hours of ordering!**

# .5" Diameter Options Selection

## Optional Exit Styles

### Right Angle Exit

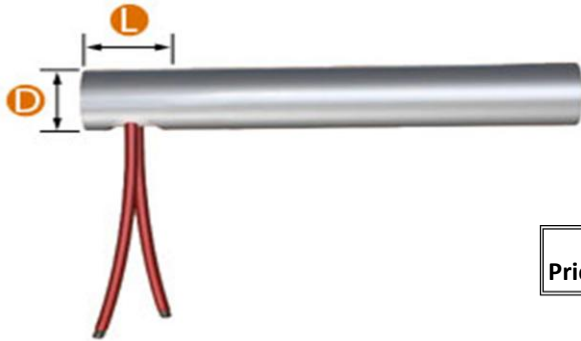

Price \$11.80

Specifications	
D	.500"
L	.625"

### Right Angle Exit with Stress Relief Tube

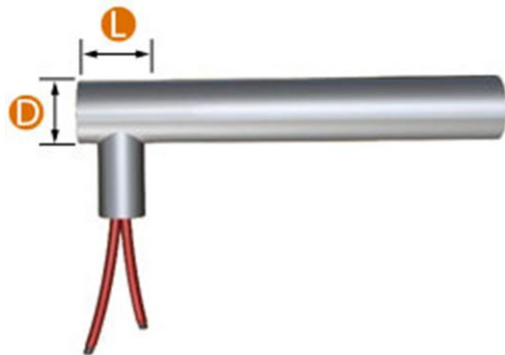

Price \$13.80

Specifications	
D	.500"
L	.625"

### Right Angle Elbow

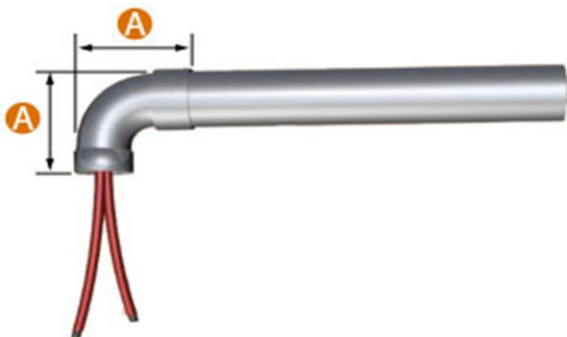

Price \$11.80

Specifications	
A	.75"

All options can be added to stock items and shipped within 24 hours of ordering!

## Stock .625" Diameter Heaters

LENGTH	VOLTS	WATTS	14" LEADS	PRICE	26" LEADS	PRICE	38" LEADS	PRICE
3	240	250	HTSS62030A-14S	\$53.52	HTSS62030A-26S	\$61.42	HTSS62030A-38S	\$69.31
3	240	400	HTSS62030B-14S	\$53.52	HTSS62030B-26S	\$61.42	HTSS62030B-38S	\$69.31
3	120	500	HTSS62030D-14S	\$53.52	HTSS62030D-26S	\$61.42	HTSS62030D-38S	\$69.31
3	240	500	HTSS62030C-14S	\$53.52	HTSS62030C-26S	\$61.42	HTSS62030C-38S	\$69.31
4	120	250	HTSS62040A-14S	\$60.80	HTSS62040A-26S	\$68.70	HTSS62040A-38S	\$76.59
4	240	500	HTSS62040B-14S	\$60.80	HTSS62040B-26S	\$68.70	HTSS62040B-38S	\$76.59
4	240	750	HTSS62040C-14S	\$60.80	HTSS62040C-26S	\$68.70	HTSS62040C-38S	\$76.59
4	240	1000	HTSS62040A-14S	\$60.80	HTSS62040A-26S	\$68.70	HTSS62040A-38S	\$76.59
5	120	250	HTSS62050A-14S	\$68.10	HTSS62050A-26S	\$75.99	HTSS62050A-38S	\$83.89
5	240	500	HTSS62050B-14S	\$68.10	HTSS62050B-26S	\$75.99	HTSS62050B-38S	\$83.89
5	240	750	HTSS62050C-14S	\$68.10	HTSS62050C-26S	\$75.99	HTSS62050C-38S	\$83.89
5	240	1000	HTSS62050A-14S	\$68.10	HTSS62050A-26S	\$75.99	HTSS62050A-38S	\$83.89
6	120	250	HTSS62060A-14S	\$75.36	HTSS62060A-26S	\$83.26	HTSS62060A-38S	\$91.15
6	120	375	HTSS62060D-14S	\$75.36	HTSS62060D-26S	\$83.26	HTSS62060D-38S	\$91.15
6	120	500	HTSS62060F-14S	\$75.36	HTSS62060F-26S	\$83.26	HTSS62060F-38S	\$91.15
6	240	500	HTSS62060B-14S	\$75.36	HTSS62060B-26S	\$83.26	HTSS62060B-38S	\$91.15
6	120	750	HTSS62060G-14S	\$75.36	HTSS62060G-26S	\$83.26	HTSS62060G-38S	\$91.15
6	240	750	HTSS62060C-14S	\$75.36	HTSS62060C-26S	\$83.26	HTSS62060C-38S	\$91.15
6	240	1000	HTSS62060A-14S	\$75.36	HTSS62060A-26S	\$83.26	HTSS62060A-38S	\$91.15
6	240	1500	HTSS62060D-14S	\$75.36	HTSS62060D-26S	\$83.26	HTSS62060D-38S	\$91.15
7	120	375	HTSS62070A-14S	\$82.64	HTSS62070A-26S	\$90.54	HTSS62070A-38S	\$98.43
7	240	500	HTSS62070C-14S	\$82.64	HTSS62070C-26S	\$90.54	HTSS62070C-38S	\$98.43
7	240	1000	HTSS62070B-14S	\$82.64	HTSS62070B-26S	\$90.54	HTSS62070B-38S	\$98.43
7	240	1500	HTSS62070A-14S	\$82.64	HTSS62070A-26S	\$90.54	HTSS62070A-38S	\$98.43
8	120	375	HTSS62080C-14S	\$89.92	HTSS62080C-26S	\$97.82	HTSS62080C-38S	\$105.71
8	120	500	HTSS62080D-14S	\$89.92	HTSS62080D-26S	\$97.82	HTSS62080D-38S	\$105.71
8	240	500	HTSS62080A-14S	\$89.92	HTSS62080A-26S	\$97.82	HTSS62080A-38S	\$105.71
8	240	750	HTSS62080E-14S	\$89.92	HTSS62080E-26S	\$97.82	HTSS62080E-38S	\$105.71
8	240	1000	HTSS62080B-14S	\$89.92	HTSS62080B-26S	\$97.82	HTSS62080B-38S	\$105.71
8	240	1500	HTSS62080C-14S	\$89.92	HTSS62080C-26S	\$97.82	HTSS62080C-38S	\$105.71
8	240	2000	HTSS62080D-14S	\$89.92	HTSS62080D-26S	\$97.82	HTSS62080D-38S	\$105.71

## Stock .625" Diameter Heaters (Continued)

LENGTH	VOLTS	WATTS	14" LEADS	PRICE	26" LEADS	PRICE	38" LEADS	PRICE
9	240	1000	HTSS62090A-14S	\$97.20	HTSS62090A-26S	\$105.10	HTSS62090A-38S	\$112.99
9	240	1500	HTSS62090B-14S	\$97.20	HTSS62090B-26S	\$105.10	HTSS62090B-38S	\$112.99
10	120	500	HTSS62100A-14S	\$104.48	HTSS62100A-26S	\$112.38	HTSS62100A-38S	\$120.27
10	240	500	HTSS62100E-14S	\$104.48	HTSS62100E-26S	\$112.38	HTSS62100E-38S	\$120.27
10	240	650	HTSS62100B-14S	\$104.48	HTSS62100B-26S	\$112.38	HTSS62100B-38S	\$120.27
10	240	750	HTSS62100F-14S	\$104.48	HTSS62100F-26S	\$112.38	HTSS62100F-38S	\$120.27
10	240	1000	HTSS62100C-14S	\$104.48	HTSS62100C-26S	\$112.38	HTSS62100C-38S	\$120.27
10	240	1500	HTSS62100D-14S	\$104.48	HTSS62100D-26S	\$112.38	HTSS62100D-38S	\$120.27
10	240	2000	HTSS62100A-14S	\$104.48	HTSS62100A-26S	\$112.38	HTSS62100A-38S	\$120.27
11	240	1000	HTSS62110A-14S	\$111.76	HTSS62110A-26S	\$119.66	HTSS62110A-38S	\$127.55
12	120	500	HTSS62120C-14S	\$119.11	HTSS62120C-26S	\$127.01	HTSS62120C-38S	\$134.90
12	240	500	HTSS62120D-14S	\$119.11	HTSS62120D-26S	\$127.01	HTSS62120D-38S	\$134.90
12	240	1000	HTSS62120A-14S	\$119.11	HTSS62120A-26S	\$127.01	HTSS62120A-38S	\$134.90
12	240	1500	HTSS62120B-14S	\$119.11	HTSS62120B-26S	\$127.01	HTSS62120B-38S	\$134.90
12	480	1500	HTSS62120E-14S	\$119.11	HTSS62120E-26S	\$127.01	HTSS62120E-38S	\$134.90
12	240	2000	HTSS62120C-14S	\$119.11	HTSS62120C-26S	\$127.01	HTSS62120C-38S	\$134.90
12	480	2000	HTSS62120D-14S	\$119.11	HTSS62120D-26S	\$127.01	HTSS62120D-38S	\$134.90
13	240	1000	HTSS62130A-14S	\$126.39	HTSS62130A-26S	\$134.29	HTSS62130A-38S	\$142.18
14	120	500	HTSS62140C-14S	\$133.67	HTSS62140C-26S	\$141.57	HTSS62140C-38S	\$149.46
14	240	1000	HTSS62140A-14S	\$133.67	HTSS62140A-26S	\$141.57	HTSS62140A-38S	\$149.46
14	240	1500	HTSS62140B-14S	\$133.67	HTSS62140B-26S	\$141.57	HTSS62140B-38S	\$149.46
14	240	2000	HTSS62140C-14S	\$133.67	HTSS62140C-26S	\$141.57	HTSS62140C-38S	\$149.46
15	120	500	HTSS62150A-14S	\$140.95	HTSS62150A-26S	\$148.85	HTSS62150A-38S	\$156.74
15	120	600	HTSS62150B-14S	\$140.95	HTSS62150B-26S	\$148.85	HTSS62150B-38S	\$156.74
15	240	750	HTSS62150C-14S	\$140.95	HTSS62150C-26S	\$148.85	HTSS62150C-38S	\$156.74
15	240	1000	HTSS62150D-14S	\$140.95	HTSS62150D-26S	\$148.85	HTSS62150D-38S	\$156.74
15	240	2000	HTSS62150A-14S	\$140.95	HTSS62150A-26S	\$148.85	HTSS62150A-38S	\$156.74
15	240	2400	HTSS62150B-14S	\$140.95	HTSS62150B-26S	\$148.85	HTSS62150B-38S	\$156.74
16	120	500	HTSS62160B-14S	\$148.23	HTSS62160B-26S	\$156.13	HTSS62160B-38S	\$164.02
16	120	625	HTSS62160C-14S	\$148.23	HTSS62160C-26S	\$156.13	HTSS62160C-38S	\$164.02
16	240	1000	HTSS62160A-14S	\$148.23	HTSS62160A-26S	\$156.13	HTSS62160A-38S	\$164.02
16	120	1125	HTSS62160D-14S	\$148.23	HTSS62160D-26S	\$156.13	HTSS62160D-38S	\$164.02
16	240	2000	HTSS62160B-14S	\$148.23	HTSS62160B-26S	\$156.13	HTSS62160B-38S	\$164.02

## Stock .625" Diameter Heaters (Continued)

LENGTH	VOLTS	WATTS	14" LEADS	PRICE	26" LEADS	PRICE	38" LEADS	PRICE
16	240	2500	HTSS62160C-14S	\$148.23	HTSS62160C-26S	\$156.13	HTSS62160C-38S	\$164.02
16	240	4500	HTSS62160D-14S	\$148.23	HTSS62160D-26S	\$156.13	HTSS62160D-38S	\$164.02
18	120	750	HTSS62180A-14S	\$162.79	HTSS62180A-26S	\$170.69	HTSS62180A-38S	\$178.58
18	240	1000	HTSS62180B-14S	\$162.79	HTSS62180B-26S	\$170.69	HTSS62180B-38S	\$178.58
18	240	1500	HTSS62180C-14S	\$162.79	HTSS62180C-26S	\$170.69	HTSS62180C-38S	\$178.58
18	240	3000	HTSS62180A-14S	\$162.79	HTSS62180A-26S	\$170.69	HTSS62180A-38S	\$178.58
20	120	875	HTSS62200A-14S	\$177.35	HTSS62200A-26S	\$185.25	HTSS62200A-38S	\$193.14
20	240	1500	HTSS62200B-14S	\$177.35	HTSS62200B-26S	\$185.25	HTSS62200B-38S	\$193.14
20	240	3500	HTSS62200A-14S	\$177.35	HTSS62200A-26S	\$185.25	HTSS62200A-38S	\$193.14
24	120	500	HTSS62240C-14S	\$206.47	HTSS62240C-26S	\$214.37	HTSS62240C-38S	\$222.26
24	240	500	HTSS62240D-14S	\$206.47	HTSS62240D-26S	\$214.37	HTSS62240D-38S	\$222.26
24	240	1000	HTSS62240A-14S	\$206.47	HTSS62240A-26S	\$214.37	HTSS62240A-38S	\$222.26
24	240	1500	HTSS62240B-14S	\$206.47	HTSS62240B-26S	\$214.37	HTSS62240B-38S	\$222.26
24	240	2000	HTSS62240C-14S	\$206.47	HTSS62240C-26S	\$214.37	HTSS62240C-38S	\$222.26
24	480	2000	HTSS62240D-14S	\$206.47	HTSS62240D-26S	\$214.37	HTSS62240D-38S	\$222.26
30	240	1500	HTSS62300A-14S	\$250.15	HTSS62300A-26S	\$258.05	HTSS62300A-38S	\$265.94
30	480	1500	HTSS62300B-14S	\$250.15	HTSS62300B-26S	\$258.05	HTSS62300B-38S	\$265.94
32	240	2000	HTSS62320A-14S	\$264.71	HTSS62320A-26S	\$272.61	HTSS62320A-38S	\$280.50

**Do not see what you need?**

**We can build to your specifications!**

# .625" Diameter Options Selection

## Lead Options



Price	No Additional Charge
-------	----------------------

**Solid Nickel Pins**  
Utilized in high heat applications and where there is no movement or vibration. Lead wires can be added via exterior crimps. Damaged wires can be replaced quickly.



Price	First 14"	Per additional 12"
	No Charge	\$2.79

### Fiberglass Leads (Standard)

Pure nickel conductors insulated with 950°F fiberglass insulation.



Price	First 14"	Per Additional 12"
	\$3.73	\$1.89

### Silicon Leads

Ideal for high movement applications where there is limited heat. Can withstand temperatures up to 450°F. Provides limited protection to moisture. Requires Silicon Potting to be utilized.



Price	First 14"	Per Additional 12"
	\$3.73	\$1.89

### Teflon Leads

Ideal for excessive movement and high vibration applications. Can withstand moderate temperatures 450°F. Provides limited protection from moisture. Requires either silicon potting or a Teflon seal.

# .625" Diameter Options Selection

## Lead Protection Options



Price	First 12"	Per Additional 12"
	\$3.99	\$1.78

### Fiberglass Sleeving

Protection against high temperatures up to 950°F while providing moderate protection against friction.



Price	First 12"	Per Additional 12"
	\$9.89	\$4.15

### Braided Metal Sleeving (BMS)

Ideal for high friction and constant bending. Stainless steel construction with high flexibility.



Price	First 12"	Per Additional 12"
	\$13.25	\$5.55

### Armor Conduit

Water resistant interlocking design allows for limited exposure to moisture. Flexibility allows an added level of protection against physical damage to the lead wires.

**All options can be added to stock items and shipped within 24 hours of ordering!**

# .625" Diameter Options Selection Page

## NPT Fittings

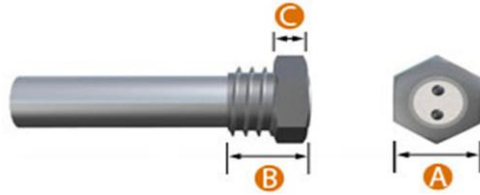

Specifications	3/8" Diameter
A	.785"
B	1.00"
C	.250"
NPT Fitting	1/2

	Stainless Steel	Brass
Price	\$19.89	\$17.97

## Right Angle Block Exit with Knockout Tab

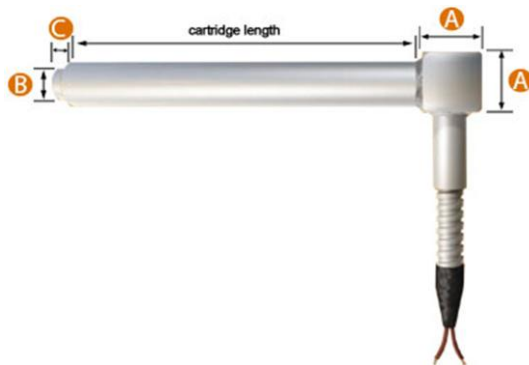

Specifications	
A	.710"
B	.196"
C	.475"

	Right Angle Block	Knockout Tab
Price	\$26.20	\$8.73

**All options can be added to stock items and shipped within 24 hours of ordering!**

# .625" Diameter Options Selection Page

## Optional Exit Styles

### Right Angle Exit

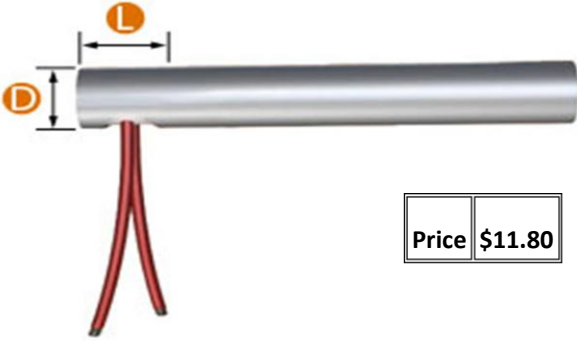

Price \$11.80

Specifications	
D	.625"
L	.625"

### Right Angle Exit with Stress Relief Tube

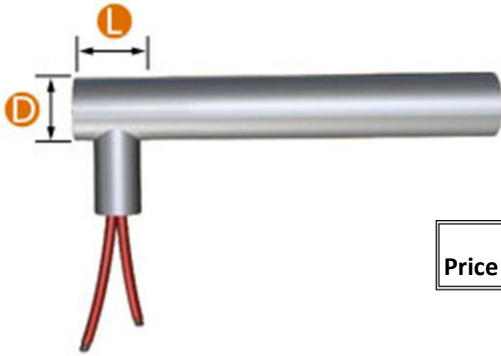

Price \$11.80

Specifications	
D	.625"
L	.625"

### Right Angle Elbow

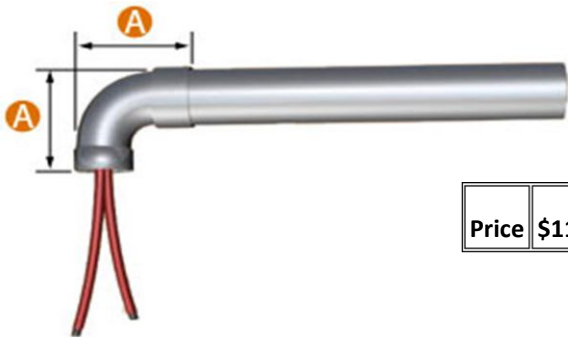

Price \$11.80

Specifications	
A	.75"

All options can be added to stock items and shipped within 24 hours of ordering!

## Stock .75" Diameter Heaters

LENGTH	OAL	VOLTS	WATTS	14" LEADS	PRICE	26" LEADS	PRICE	38" LEADS
2	240	250	HTSS75020A-14S	\$52.47	HTSS75020A-26S	\$60.37	HTSS75020A-38S	\$68.26
3	240	225	HTSS75030A-14S	\$61.64	HTSS75030A-26S	\$69.54	HTSS75030A-38S	\$77.43
3	240	400	HTSS75030B-14S	\$61.64	HTSS75030B-26S	\$69.54	HTSS75030B-38S	\$77.43
3	120	500	HTSS75030C-14S	\$61.64	HTSS75030C-26S	\$69.54	HTSS75030C-38S	\$77.43
3	240	500	HTSS75030D-14S	\$61.64	HTSS75030D-26S	\$69.54	HTSS75030D-38S	\$77.43
4	120	250	HTSS75040B-14S	\$72.21	HTSS75040B-26S	\$80.11	HTSS75040B-38S	\$88.00
4	240	750	HTSS75040A-14S	\$72.21	HTSS75040A-26S	\$80.11	HTSS75040A-38S	\$88.00
4	240	1000	HTSS75040B-14S	\$72.21	HTSS75040B-26S	\$80.11	HTSS75040B-38S	\$88.00
5	120	250	HTSS75050B-14S	\$79.91	HTSS75050B-26S	\$87.81	HTSS75050B-38S	\$95.70
5	240	500	HTSS75050A-14S	\$79.91	HTSS75050A-26S	\$87.81	HTSS75050A-38S	\$95.70
5	240	1000	HTSS75050B-14S	\$79.91	HTSS75050B-26S	\$87.81	HTSS75050B-38S	\$95.70
6	120	375	HTSS75060E-14S	\$89.08	HTSS75060E-26S	\$96.98	HTSS75060E-38S	\$104.87
6	120	500	HTSS75060A-14S	\$89.08	HTSS75060A-26S	\$96.98	HTSS75060A-38S	\$104.87
6	240	500	HTSS75060B-14S	\$89.08	HTSS75060B-26S	\$96.98	HTSS75060B-38S	\$104.87
6	240	1000	HTSS75060C-14S	\$89.08	HTSS75060C-26S	\$96.98	HTSS75060C-38S	\$104.87
6	240	1200	HTSS75060D-14S	\$89.08	HTSS75060D-26S	\$96.98	HTSS75060D-38S	\$104.87
6	240	1500	HTSS75060E-14S	\$89.08	HTSS75060E-26S	\$96.98	HTSS75060E-38S	\$104.87
6	240	2000	HTSS75060A-14S	\$89.08	HTSS75060A-26S	\$96.98	HTSS75060A-38S	\$104.87
7	120	375	HTSS75070C-14S	\$98.25	HTSS75070C-26S	\$106.15	HTSS75070C-38S	\$114.04
7	240	500	HTSS75070A-14S	\$98.25	HTSS75070A-26S	\$106.15	HTSS75070A-38S	\$114.04
7	240	1000	HTSS75070B-14S	\$98.25	HTSS75070B-26S	\$106.15	HTSS75070B-38S	\$114.04
7	240	1500	HTSS75070C-14S	\$98.25	HTSS75070C-26S	\$106.15	HTSS75070C-38S	\$114.04
8	120	350	HTSS75080C-14S	\$107.42	HTSS75080C-26S	\$115.32	HTSS75080C-38S	\$123.21
8	240	350	HTSS75080E-14S	\$107.42	HTSS75080E-26S	\$115.32	HTSS75080E-38S	\$123.21
8	120	500	HTSS75080D-14S	\$107.42	HTSS75080D-26S	\$115.32	HTSS75080D-38S	\$123.21
8	240	600	HTSS75080A-14S	\$107.42	HTSS75080A-26S	\$115.32	HTSS75080A-38S	\$123.21
8	240	750	HTSS75080F-14S	\$107.42	HTSS75080F-26S	\$115.32	HTSS75080F-38S	\$123.21
8	240	1000	HTSS75080B-14S	\$107.42	HTSS75080B-26S	\$115.32	HTSS75080B-38S	\$123.21
8	240	1500	HTSS75080C-14S	\$107.42	HTSS75080C-26S	\$115.32	HTSS75080C-38S	\$123.21
8	480	1500	HTSS75080E-14S	\$107.42	HTSS75080E-26S	\$115.32	HTSS75080E-38S	\$123.21
8	240	2000	HTSS75080D-14S	\$107.42	HTSS75080D-26S	\$115.32	HTSS75080D-38S	\$123.21

## Stock .75" Diameter Heaters (Continued)

LENGTH	OAL	VOLTS	WATTS	14" LEADS	PRICE	26" LEADS	PRICE	38" LEADS
9	120	350	HTSS75090D-14S	\$116.52	HTSS75090D-26S	\$124.42	HTSS75090D-38S	\$132.31
9	240	350	HTSS75090B-14S	\$116.52	HTSS75090B-26S	\$124.42	HTSS75090B-38S	\$132.31
9	240	1000	HTSS75090C-14S	\$116.52	HTSS75090C-26S	\$124.42	HTSS75090C-38S	\$132.31
9	240	1400	HTSS75090D-14S	\$116.52	HTSS75090D-26S	\$124.42	HTSS75090D-38S	\$132.31
9	480	1400	HTSS75090B-14S	\$116.52	HTSS75090B-26S	\$124.42	HTSS75090B-38S	\$132.31
9	240	1800	HTSS75090A-14S	\$116.52	HTSS75090A-26S	\$124.42	HTSS75090A-38S	\$132.31
10	120	500	HTSS75100C-14S	\$125.69	HTSS75100C-26S	\$133.59	HTSS75100C-38S	\$141.48
10	120	750	HTSS75100F-14S	\$125.69	HTSS75100F-26S	\$133.59	HTSS75100F-38S	\$141.48
10	240	1000	HTSS75100A-14S	\$125.69	HTSS75100A-26S	\$133.59	HTSS75100A-38S	\$141.48
10	240	1200	HTSS75100E-14S	\$125.69	HTSS75100E-26S	\$133.59	HTSS75100E-38S	\$141.48
10	240	1500	HTSS75100B-14S	\$125.69	HTSS75100B-26S	\$133.59	HTSS75100B-38S	\$141.48
10	240	2000	HTSS75100C-14S	\$125.69	HTSS75100C-26S	\$133.59	HTSS75100C-38S	\$141.48
10	240	3000	HTSS75100F-14S	\$125.69	HTSS75100F-26S	\$133.59	HTSS75100F-38S	\$141.48
12	120	500	HTSS75120D-14S	\$144.03	HTSS75120D-26S	\$151.93	HTSS75120D-38S	\$159.82
12	240	500	HTSS75120E-14S	\$144.03	HTSS75120E-26S	\$151.93	HTSS75120E-38S	\$159.82
12	120	1000	HTSS75120A-14S	\$144.03	HTSS75120A-26S	\$151.93	HTSS75120A-38S	\$159.82
12	240	1000	HTSS75120B-14S	\$144.03	HTSS75120B-26S	\$151.93	HTSS75120B-38S	\$159.82
12	240	1500	HTSS75120C-14S	\$144.03	HTSS75120C-26S	\$151.93	HTSS75120C-38S	\$159.82
12	240	2000	HTSS75120D-14S	\$144.03	HTSS75120D-26S	\$151.93	HTSS75120D-38S	\$159.82
12	480	2000	HTSS75120E-14S	\$144.03	HTSS75120E-26S	\$151.93	HTSS75120E-38S	\$159.82
12	240	2500	HTSS75120F-14S	\$144.03	HTSS75120F-26S	\$151.93	HTSS75120F-38S	\$159.82
14	240	2000	HTSS75140A-14S	\$162.37	HTSS75140A-26S	\$170.27	HTSS75140A-38S	\$178.16
14	240	4500	HTSS75140B-14S	\$162.37	HTSS75140B-26S	\$170.27	HTSS75140B-38S	\$178.16
15	240	1000	HTSS75150A-14S	\$171.47	HTSS75150A-26S	\$179.37	HTSS75150A-38S	\$187.26
16	240	875	HTSS75160B-14S	\$180.64	HTSS75160B-26S	\$188.54	HTSS75160B-38S	\$196.43
16	240	1000	HTSS75160C-14S	\$180.64	HTSS75160C-26S	\$188.54	HTSS75160C-38S	\$196.43
16	240	1600	HTSS75160A-14S	\$180.64	HTSS75160A-26S	\$188.54	HTSS75160A-38S	\$196.43
16	480	3500	HTSS75160B-14S	\$180.64	HTSS75160B-26S	\$188.54	HTSS75160B-38S	\$196.43
12	240	2000	HTSS75120D-14S	\$144.03	HTSS75120D-26S	\$151.93	HTSS75120D-38S	\$159.82
12	480	2000	HTSS75120E-14S	\$144.03	HTSS75120E-26S	\$151.93	HTSS75120E-38S	\$159.82
12	240	2500	HTSS75120F-14S	\$144.03	HTSS75120F-26S	\$151.93	HTSS75120F-38S	\$159.82
14	240	2000	HTSS75140A-14S	\$162.37	HTSS75140A-26S	\$170.27	HTSS75140A-38S	\$178.16
14	240	4500	HTSS75140B-14S	\$162.37	HTSS75140B-26S	\$170.27	HTSS75140B-38S	\$178.16

## Stock .75" Diameter Heaters (Continued)

LENGTH	OAL	VOLTS	WATTS	14" LEADS	PRICE	26" LEADS	PRICE	38" LEADS
15	240	1000	HTSS75150A-14S	\$171.47	HTSS75150A-26S	\$179.37	HTSS75150A-38S	\$187.26
16	240	875	HTSS75160B-14S	\$180.64	HTSS75160B-26S	\$188.54	HTSS75160B-38S	\$196.43
16	240	1000	HTSS75160C-14S	\$180.64	HTSS75160C-26S	\$188.54	HTSS75160C-38S	\$196.43
16	240	1600	HTSS75160A-14S	\$180.64	HTSS75160A-26S	\$188.54	HTSS75160A-38S	\$196.43
16	480	3500	HTSS75160B-14S	\$180.64	HTSS75160B-26S	\$188.54	HTSS75160B-38S	\$196.43
18	240	1000	HTSS75180A-14S	\$198.98	HTSS75180A-26S	\$206.88	HTSS75180A-38S	\$214.77
18	240	2000	HTSS75180B-14S	\$198.98	HTSS75180B-26S	\$206.88	HTSS75180B-38S	\$214.77
18	480	2000	HTSS75180C-14S	\$198.98	HTSS75180C-26S	\$206.88	HTSS75180C-38S	\$214.77
18	240	2400	HTSS75180D-14S	\$198.98	HTSS75180D-26S	\$206.88	HTSS75180D-38S	\$214.77
20	240	1200	HTSS75200A-14S	\$217.25	HTSS75200A-26S	\$225.15	HTSS75200A-38S	\$233.04
20	240	2250	HTSS75200B-14S	\$217.25	HTSS75200B-26S	\$225.15	HTSS75200B-38S	\$233.04
24	240	1000	HTSS75240A-14S	\$253.93	HTSS75240A-26S	\$261.83	HTSS75240A-38S	\$269.72
24	240	1500	HTSS75240B-14S	\$253.93	HTSS75240B-26S	\$261.83	HTSS75240B-38S	\$269.72
24	240	2000	HTSS75240C-14S	\$253.93	HTSS75240C-26S	\$261.83	HTSS75240C-38S	\$269.72
24	480	2500	HTSS75240D-14S	\$253.93	HTSS75240D-26S	\$261.83	HTSS75240D-38S	\$269.72
24	240	3000	HTSS75240E-14S	\$253.93	HTSS75240E-26S	\$261.83	HTSS75240E-38S	\$269.72
24	480	4000	HTSS75240A-14S	\$253.93	HTSS75080C-26S	\$261.83	HTSS75080C-38S	\$269.72
28	240	2400	HTSS75280A-14S	\$290.61	HTSS75280A-26S	\$298.51	HTSS75280A-38S	\$306.40
30	240	2000	HTSS75300A-14S	\$308.95	HTSS75300A-26S	\$316.85	HTSS75300A-38S	\$324.74
32	240	2000	HTSS75320A-14S	\$327.29	HTSS75320A-26S	\$335.19	HTSS75320A-38S	\$343.08
36	240	2000	HTSS75360A-14S	\$363.97	HTSS75360A-26S	\$371.87	HTSS75360A-38S	\$379.76

**Do not see what you need?**

**We can build to your specifications!**

# .75" Diameter Options Selection

## Lead Options



Price	No Additional Charge
-------	----------------------

**Solid Nickel Pins**  
Utilized in high heat applications and where there is no movement or vibration. Lead wires can be added via exterior crimps. Damaged wires can be replaced quickly.



Price	First 14"	Per Additional 12"
	No Charge	\$2.79

**Fiberglass Leads (Standard)**  
Pure nickel conductors insulated with 950°F fiberglass insulation.



Price	First 14"	Per Additional 12"
	\$3.73	\$1.89

**Silicon Leads**  
Ideal for high movement applications where there is limited heat. Can withstand temperatures up to 450°F. Provides limited protection to moisture. Requires Silicon Potting to be utilized.



Price	First 14"	Per Additional 12"
	\$3.73	\$1.89

**Teflon Leads**  
Ideal for excessive movement and high vibration applications. Can withstand moderate temperatures 450°F. Provides limited protection from moisture. Requires either silicon potting or a Teflon seal.

# .75" Diameter Options Selection Page

## Lead Protection Options



Price	First 12"	Per Additional 12"
	\$3.99	\$1.78

### Fiberglass Sleeving

Protection against high temperatures up to 950°F while providing moderate protection against friction.



Price	First 12"	Per Additional 12"
	\$9.89	\$4.15

### Braided Metal Sleeving (BMS)

Ideal for high friction and constant bending. Stainless steel construction with high flexibility.



Price	First 12"	Per Additional 12"
	\$13.25	\$5.55

### Armor Conduit

Water resistant interlocking design allows for limited exposure to moisture. Flexibility allows an added level of protection against physical damage to the lead wires.

**All options can be added to stock items and shipped within 24 hours of ordering!**

# .75" Diameter Options Selection

## NPT Fittings

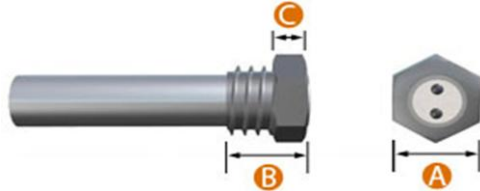

	Stainless Steel	Brass
Price	\$27.89	\$25.97

Specifications	.75" Diameter
A	.100"
B	1.18"
C	.275"
NPT Fitting	3/4

## Right Angle Block Exit with Knockout Tab

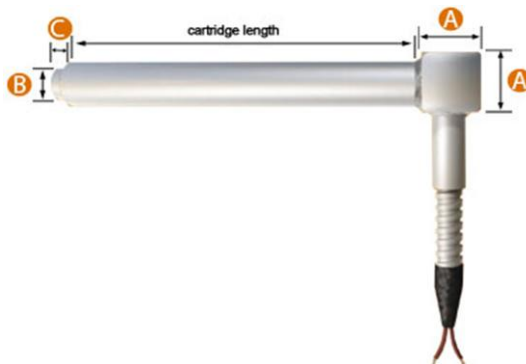

Specifications	
A	.866"
B	.590"
C	.196"

	Right Angle Block	Knockout Tab
Price	\$30.20	\$12.73

**All options can be added to stock items and shipped within 24 hours of ordering!**

# .75" Diameter Options Selection Page

## Optional Exit Styles

### Right Angle Exit

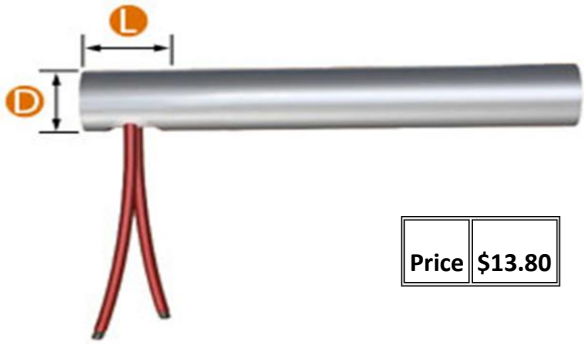

Price \$13.80

Specifications	
D	.75"
L	.625"

### Right Angle Exit with Stress Relief Tube

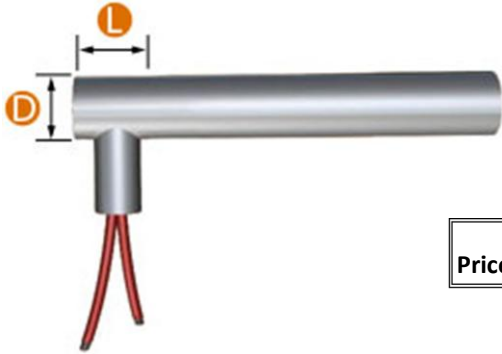

Price \$16.80

Specifications	
D	.75"
L	.625"

### Right Angle Elbow

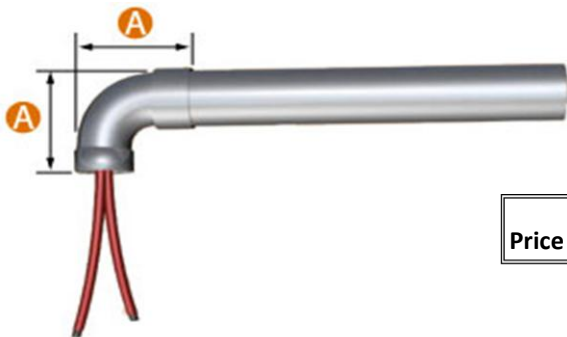

Price \$13.80

Specifications	
A	.75"

All options can be added to stock items and shipped within 24 hours of ordering!

# Stock 1" Diameter Heaters

LENGTH	OAL	VOLTS	WATTS	14" LEADS	PRICE	26" LEADS	PRICE	38" LEADS
2	240	250	HTSS10020A-14S	\$55.10	HTSS10020A-26S	\$63.39	HTSS10020A-38S	\$71.68
3	240	225	HTSS10030A-14S	\$64.72	HTSS10030A-26S	\$73.01	HTSS10030A-38S	\$81.31
3	240	400	HTSS10030B-14S	\$64.72	HTSS10030B-26S	\$73.01	HTSS10030B-38S	\$81.31
3	120	500	HTSS10030C-14S	\$64.72	HTSS10030C-26S	\$73.01	HTSS10030C-38S	\$81.31
3	240	500	HTSS10030D-14S	\$64.72	HTSS10030D-26S	\$73.01	HTSS10030D-38S	\$81.31
4	120	250	HTSS10040B-14S	\$75.82	HTSS10040B-26S	\$84.11	HTSS10040B-38S	\$92.40
4	240	750	HTSS10040A-14S	\$75.82	HTSS10040A-26S	\$84.11	HTSS10040A-38S	\$92.40
4	240	1000	HTSS10040B-14S	\$75.82	HTSS10040B-26S	\$84.11	HTSS10040B-38S	\$92.40
5	120	250	HTSS10050B-14S	\$83.91	HTSS10050B-26S	\$92.20	HTSS10050B-38S	\$100.49
5	240	500	HTSS10050A-14S	\$83.91	HTSS10050A-26S	\$92.20	HTSS10050A-38S	\$100.49
5	240	1000	HTSS10050B-14S	\$83.91	HTSS10050B-26S	\$92.20	HTSS10050B-38S	\$100.49
6	120	375	HTSS10060E-14S	\$93.54	HTSS10060E-26S	\$101.83	HTSS10060E-38S	\$110.12
6	120	500	HTSS10060A-14S	\$93.54	HTSS10060A-26S	\$101.83	HTSS10060A-38S	\$110.12
6	240	500	HTSS10060B-14S	\$93.54	HTSS10060B-26S	\$101.83	HTSS10060B-38S	\$110.12
6	240	1000	HTSS10060C-14S	\$93.54	HTSS10060C-26S	\$101.83	HTSS10060C-38S	\$110.12
6	240	1200	HTSS10060D-14S	\$93.54	HTSS10060D-26S	\$101.83	HTSS10060D-38S	\$110.12
6	240	1500	HTSS10060E-14S	\$93.54	HTSS10060E-26S	\$101.83	HTSS10060E-38S	\$110.12
6	240	2000	HTSS10060A-14S	\$93.54	HTSS10060A-26S	\$101.83	HTSS10060A-38S	\$110.12
7	120	375	HTSS10070C-14S	\$103.16	HTSS10070C-26S	\$111.46	HTSS10070C-38S	\$119.75
7	240	500	HTSS10070A-14S	\$103.16	HTSS10070A-26S	\$111.46	HTSS10070A-38S	\$119.75
7	240	1000	HTSS10070B-14S	\$103.16	HTSS10070B-26S	\$111.46	HTSS10070B-38S	\$119.75
7	240	1500	HTSS10070C-14S	\$103.16	HTSS10070C-26S	\$111.46	HTSS10070C-38S	\$119.75
8	120	350	HTSS10080C-14S	\$112.79	HTSS10080C-26S	\$121.08	HTSS10080C-38S	\$129.37
8	240	350	HTSS10080E-14S	\$112.79	HTSS10080E-26S	\$121.08	HTSS10080E-38S	\$129.37
8	120	500	HTSS10080D-14S	\$112.79	HTSS10080D-26S	\$121.08	HTSS10080D-38S	\$129.37
8	240	600	HTSS10080A-14S	\$112.79	HTSS10080A-26S	\$121.08	HTSS10080A-38S	\$129.37
8	240	750	HTSS10080F-14S	\$112.79	HTSS10080F-26S	\$121.08	HTSS10080F-38S	\$129.37
8	240	1000	HTSS10080B-14S	\$112.79	HTSS10080B-26S	\$121.08	HTSS10080B-38S	\$129.37
8	240	1500	HTSS10080C-14S	\$112.79	HTSS10080C-26S	\$121.08	HTSS10080C-38S	\$129.37
8	480	1500	HTSS10080E-14S	\$112.79	HTSS10080E-26S	\$121.08	HTSS10080E-38S	\$129.37
8	240	2000	HTSS10080D-14S	\$112.79	HTSS10080D-26S	\$121.08	HTSS10080D-38S	\$129.37

## Stock 1" Diameter Heaters (Continued)

LENGTH	OAL	VOLTS	WATTS	14" LEADS	PRICE	26" LEADS	PRICE	38" LEADS
9	120	350	HTSS10090D-14S	\$122.35	HTSS10090D-26S	\$130.64	HTSS10090D-38S	\$138.93
9	240	350	HTSS10090B-14S	\$122.35	HTSS10090B-26S	\$130.64	HTSS10090B-38S	\$138.93
9	240	1000	HTSS10090C-14S	\$122.35	HTSS10090C-26S	\$130.64	HTSS10090C-38S	\$138.93
9	240	1400	HTSS10090D-14S	\$122.35	HTSS10090D-26S	\$130.64	HTSS10090D-38S	\$138.93
9	480	1400	HTSS10090B-14S	\$122.35	HTSS10090B-26S	\$130.64	HTSS10090B-38S	\$138.93
9	240	1800	HTSS10090A-14S	\$122.35	HTSS10090A-26S	\$130.64	HTSS10090A-38S	\$138.93
10	120	500	HTSS10100C-14S	\$131.98	HTSS10100C-26S	\$140.27	HTSS10100C-38S	\$148.56
10	120	750	HTSS10100F-14S	\$131.98	HTSS10100F-26S	\$140.27	HTSS10100F-38S	\$148.56
10	240	1000	HTSS10100A-14S	\$131.98	HTSS10100A-26S	\$140.27	HTSS10100A-38S	\$148.56
10	240	1200	HTSS10100E-14S	\$131.98	HTSS10100E-26S	\$140.27	HTSS10100E-38S	\$148.56
10	240	1500	HTSS10100B-14S	\$131.98	HTSS10100B-26S	\$140.27	HTSS10100B-38S	\$148.56
10	240	2000	HTSS10100C-14S	\$131.98	HTSS10100C-26S	\$140.27	HTSS10100C-38S	\$148.56
10	240	3000	HTSS10100F-14S	\$131.98	HTSS10100F-26S	\$140.27	HTSS10100F-38S	\$148.56
12	120	500	HTSS10120D-14S	\$151.23	HTSS10120D-26S	\$159.52	HTSS10120D-38S	\$167.82
12	240	500	HTSS10120E-14S	\$151.23	HTSS10120E-26S	\$159.52	HTSS10120E-38S	\$167.82
12	120	1000	HTSS10120A-14S	\$151.23	HTSS10120A-26S	\$159.52	HTSS10120A-38S	\$167.82
12	240	1000	HTSS10120B-14S	\$151.23	HTSS10120B-26S	\$159.52	HTSS10120B-38S	\$167.82
12	240	1500	HTSS10120C-14S	\$151.23	HTSS10120C-26S	\$159.52	HTSS10120C-38S	\$167.82
12	240	2000	HTSS10120D-14S	\$151.23	HTSS10120D-26S	\$159.52	HTSS10120D-38S	\$167.82
12	480	2000	HTSS10120E-14S	\$151.23	HTSS10120E-26S	\$159.52	HTSS10120E-38S	\$167.82
12	240	2500	HTSS10120F-14S	\$151.23	HTSS10120F-26S	\$159.52	HTSS10120F-38S	\$167.82
14	240	2000	HTSS10140A-14S	\$170.49	HTSS10140A-26S	\$178.78	HTSS10140A-38S	\$187.07
14	240	4500	HTSS10140B-14S	\$170.49	HTSS10140B-26S	\$178.78	HTSS10140B-38S	\$187.07
15	240	1000	HTSS10150A-14S	\$180.05	HTSS10150A-26S	\$188.34	HTSS10150A-38S	\$196.63
16	240	875	HTSS10160B-14S	\$189.67	HTSS10160B-26S	\$197.96	HTSS10160B-38S	\$206.26
16	240	1000	HTSS10160C-14S	\$189.67	HTSS10160C-26S	\$197.96	HTSS10160C-38S	\$206.26
16	240	1600	HTSS10160A-14S	\$189.67	HTSS10160A-26S	\$197.96	HTSS10160A-38S	\$206.26
16	480	3500	HTSS10160B-14S	\$189.67	HTSS10160B-26S	\$197.96	HTSS10160B-38S	\$206.26
12	240	2000	HTSS10120D-14S	\$151.23	HTSS10120D-26S	\$159.52	HTSS10120D-38S	\$167.82
12	480	2000	HTSS10120E-14S	\$151.23	HTSS10120E-26S	\$159.52	HTSS10120E-38S	\$167.82
12	240	2500	HTSS10120F-14S	\$151.23	HTSS10120F-26S	\$159.52	HTSS10120F-38S	\$167.82
14	240	2000	HTSS10140A-14S	\$170.49	HTSS10140A-26S	\$178.78	HTSS10140A-38S	\$187.07
14	240	4500	HTSS10140B-14S	\$170.49	HTSS10140B-26S	\$178.78	HTSS10140B-38S	\$187.07

## Stock 1" Diameter Heaters (Continued)

LENGTH	OAL	VOLTS	WATTS	14" LEADS	PRICE	26" LEADS	PRICE	38" LEADS
15	240	1000	HTSS10150A-14S	\$180.05	HTSS10150A-26S	\$188.34	HTSS10150A-38S	\$196.63
16	240	875	HTSS10160B-14S	\$189.67	HTSS10160B-26S	\$197.96	HTSS10160B-38S	\$206.26
16	240	1000	HTSS10160C-14S	\$189.67	HTSS10160C-26S	\$197.96	HTSS10160C-38S	\$206.26
16	240	1600	HTSS10160A-14S	\$189.67	HTSS10160A-26S	\$197.96	HTSS10160A-38S	\$206.26
16	480	3500	HTSS10160B-14S	\$189.67	HTSS10160B-26S	\$197.96	HTSS10160B-38S	\$206.26
18	240	1000	HTSS10180A-14S	\$208.93	HTSS10180A-26S	\$217.22	HTSS10180A-38S	\$225.51
18	240	2000	HTSS10180B-14S	\$208.93	HTSS10180B-26S	\$217.22	HTSS10180B-38S	\$225.51
18	480	2000	HTSS10180C-14S	\$208.93	HTSS10180C-26S	\$217.22	HTSS10180C-38S	\$225.51
18	240	2400	HTSS10180D-14S	\$208.93	HTSS10180D-26S	\$217.22	HTSS10180D-38S	\$225.51
20	240	1200	HTSS10200A-14S	\$228.11	HTSS10200A-26S	\$236.41	HTSS10200A-38S	\$244.70
20	240	2250	HTSS10200B-14S	\$228.11	HTSS10200B-26S	\$236.41	HTSS10200B-38S	\$244.70
24	240	1000	HTSS10240A-14S	\$266.63	HTSS10240A-26S	\$274.92	HTSS10240A-38S	\$283.21
24	240	1500	HTSS10240B-14S	\$266.63	HTSS10240B-26S	\$274.92	HTSS10240B-38S	\$283.21
24	240	2000	HTSS10240C-14S	\$266.63	HTSS10240C-26S	\$274.92	HTSS10240C-38S	\$283.21
24	480	2500	HTSS10240D-14S	\$266.63	HTSS10240D-26S	\$274.92	HTSS10240D-38S	\$283.21
24	240	3000	HTSS10240E-14S	\$266.63	HTSS10240E-26S	\$274.92	HTSS10240E-38S	\$283.21
24	480	4000	HTSS10240A-14S	\$266.63	HTSS10080C-26S	\$274.92	HTSS10080C-38S	\$283.21
28	240	2400	HTSS10280A-14S	\$305.14	HTSS10280A-26S	\$313.43	HTSS10280A-38S	\$321.72
30	240	2000	HTSS10300A-14S	\$324.40	HTSS10300A-26S	\$332.69	HTSS10300A-38S	\$340.98
32	240	2000	HTSS10320A-14S	\$343.66	HTSS10320A-26S	\$351.95	HTSS10320A-38S	\$360.24
36	240	2000	HTSS10360A-14S	\$382.17	HTSS10360A-26S	\$390.46	HTSS10360A-38S	\$398.75

**Do not see what you need?**

**We can build to your specifications!**

# 1" Diameter Options Selection

## Lead Options



Price	No Additional Charge
-------	----------------------

**Solid Nickel Pins**  
Utilized in high heat applications and where there is no movement or vibration. Lead wires can be added via exterior crimps. Damaged wires can be replaced quickly.



Price	First 14"	Per Additional 12"
	No Charge	\$2.79

**Fiberglass Leads (Standard)**  
Pure nickel conductors insulated with 950°F fiberglass insulation.



Price	First 14"	Per Additional 12"
	\$3.73	\$1.89

**Silicon Leads**  
Ideal for high movement applications where there is limited heat. Can withstand temperatures up to 450°F. Provides limited protection to moisture. Requires Silicon Potting to be utilized.



Price	First 14"	Per Additional 12"
	\$3.73	\$1.89

**Teflon Leads**  
Ideal for excessive movement and high vibration applications. Can withstand moderate temperatures 450°F. Provides limited protection from moisture. Requires either silicon potting or a Teflon seal.

# 1" Diameter Options Selection Page

## Lead Protection Options



Price	First 12"	Per Additional 12"
	\$3.99	\$1.78

### Fiberglass Sleeving

Protection against high temperatures up to 950°F while providing moderate protection against friction.



Price	First 12"	Per Additional 12"
	\$9.89	\$4.15

### Braided Metal Sleeving (BMS)

Ideal for high friction and constant bending. Stainless steel construction with high flexibility.



Price	First 12"	Per Additional 12"
	\$13.25	\$5.55

### Armor Conduit

Water resistant interlocking design allows for limited exposure to moisture. Flexibility allows an added level of protection against physical damage to the lead wires.

**All options can be added to stock items and shipped within 24 hours of ordering!**

# 1" Diameter Options Selection

## NPT Fittings

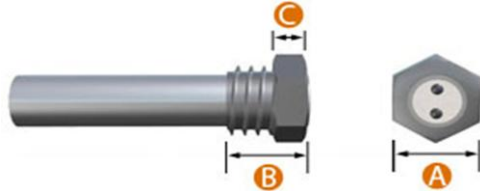

	Stainless Steel	Brass
Price	\$27.89	\$25.97

Specifications	.75" Diameter
A	.100"
B	1.18"
C	.275"
NPT Fitting	3/4

## Right Angle Block Exit with Knockout Tab

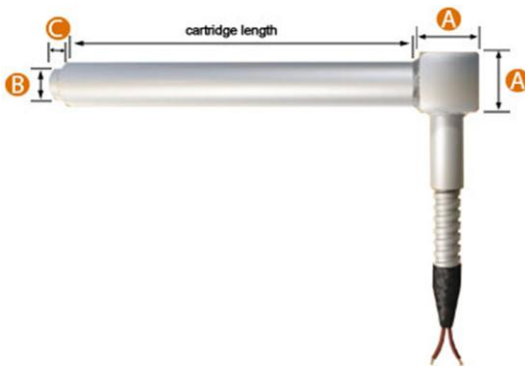

Specifications	
A	.866"
B	.590"
C	.196"

	Right Angle Block	Knockout Tab
Price	\$30.20	\$12.73

**All options can be added to stock items and shipped within 24 hours of ordering!**

# 1" Diameter Options Selection Page

## Optional Exit Styles

### Right Angle Exit

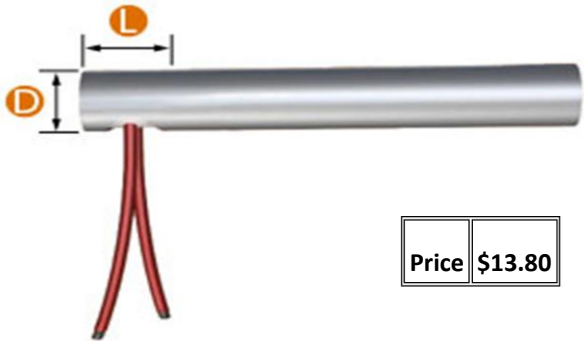

Price \$13.80

Specifications	
D	.75"
L	.625"

### Right Angle Exit with Stress Relief Tube

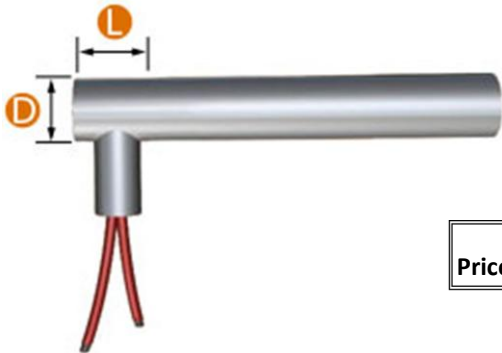

Price \$16.80

Specifications	
D	.75"
L	.625"

### Right Angle Elbow

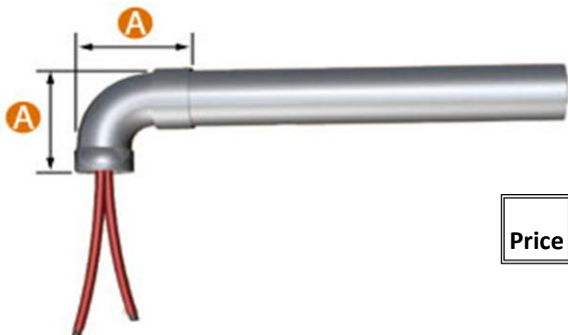

Price \$13.80

Specifications	
A	.75"

All options can be added to stock items and shipped

# High-Temp Industries

## Other Quality Products



Cartridge Heaters



Split Sheath Heaters



Cast in Coil Heaters



Platinum Heaters



Nozzle Heaters



Cast Heaters



Tubular Heaters



Ceramic Band Heaters



PID Controllers



Thermocouples



Hot Runner Cables



Hot Runner Controllers

And more.....[www.high-temp.com](http://www.high-temp.com)